

DUKANE

**Liquid Crystal Projector
Models 8805 & 8946**

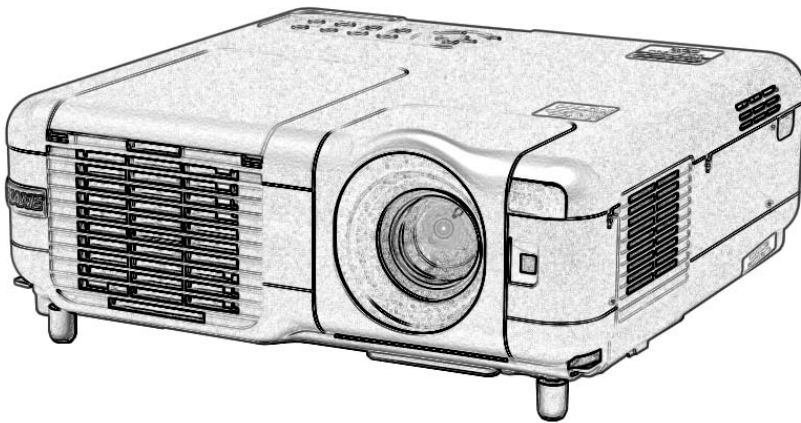

USER'S MANUAL

Important Information

Safety Cautions

Precautions

Please read this manual carefully before using your Dukane 8805/8946 Projector and keep the manual handy for future reference. Your serial number is located on the right side of your projector. Record it here:

CAUTION
 To turn off main power, be sure to remove the plug from power outlet.
 The power outlet socket should be installed as near to the equipment as possible, and should be easily accessible.

CAUTION
 TO PREVENT SHOCK, DO NOT OPEN THE CABINET. NO USER-SERVICEABLE PARTS INSIDE. REFER SERVICING TO QUALIFIED SERVICE PERSONNEL.

 This symbol warns the user that uninsulated voltage within the unit may be sufficient to cause electrical shock. Therefore, it is dangerous to make any kind of contact with any part inside of the unit.

 This symbol alerts the user that important information concerning the operation and maintenance of this unit has been provided. The information should be read carefully to avoid problems.

WARNING
 TO PREVENT FIRE OR SHOCK, DO NOT EXPOSE THIS UNIT TO RAIN OR MOISTURE.
 DO NOT USE THIS UNIT'S GROUNDED PLUG WITH AN EXTENSION CORD OR IN AN OUTLET UNLESS ALL THE PRONGS CAN BE FULLY INSERTED.
 DO NOT OPEN THE CABINET. THERE ARE HIGH-VOLTAGE COMPONENTS INSIDE. ALL SERVICING MUST BE DONE BY QUALIFIED DUKANE SERVICE PERSONNEL.

DOC Compliance Notice

This Class B digital apparatus meets all requirements of the Canadian Interference-Causing Equipment Regulations.

Acoustic Noise Information Ordinance-3. GSGV:

The sound pressure level is less than 70 dB (A) according to ISO 3744 or ISO 7779.

CAUTION 注意	RADIACION LASER NO MIRE AL RAYO PRODUCTO LASER CLASSE2	RAYONNEMENT LASER NE PAS REGARDER DANS LE FAISCEAU APPAREIL A LASER DE CLASSE2	激光照射 勿直视 激光束
	LASER STRAHLUNG NICHT IN DEN STRAHL BLICKEN LASER KLASSE2	レーザー光 1mW max. 650nm ビームをのぞきまさないこと	激光产品
LASER RADIATION DO NOT STARE INTO BEAM	WAVE LENGTH: 650nm MAX. OUTPUT: 1mW	CLASS II LASER PRODUCT	CLASS 2 LASER PRODUCT
<small>EN60825-1:1994+A2:2001+A1:2002 JIS C 6802:1998 IEC 60825-1:1993+A1:1997+A2:2001</small>			

This label is on the side of the remote control.

CAUTION
 Do not look into the laser pointer while it is on and do not point the laser beam at a person. Serious injury could result.

WARNING TO CALIFORNIA RESIDENTS:
 Handling the cables supplied with this product, will expose you to lead, a chemical known to the State of California to cause birth defects or other reproductive harm. Wash hands after handling.

RF Interference

WARNING
 The Federal Communications Commission does not allow any modifications or changes to the unit EXCEPT those specified by Dukane Corporation AV Division in this manual. Failure to comply with this government regulation could void your right to operate this equipment. This equipment has been tested and found to comply with the limits for a Class B digital device, pursuant to Part 15 of the FCC Rules. These limits are designed to provide reasonable protection against harmful interference in a residential installation. This equipment generates, uses, and can radiate radio frequency energy and, if not installed and used in accordance with the instructions, may cause harmful interference to radio communications. However, there is no guarantee that interference will not occur in a particular installation. If this equipment does cause harmful interference to radio or television reception, which can be determined by turning the equipment off and on, the user is encouraged to try to correct the interference by one or more of the following measures:

- Reorient or relocate the receiving antenna.
- Increase the separation between the equipment and receiver.
- Connect the equipment into an outlet on a circuit different from that to which the receiver is connected.
- Consult the dealer or an experienced radio / TV technician for help.

In UK, a BS approved power cable with moulded plug has a Black (five Amps) fuse installed for use with this equipment. If a power cable is not supplied with this equipment please contact your supplier.

Important Safeguards

These safety instructions are to ensure the long life of your projector and to prevent fire and shock. Please read them carefully and heed all warnings.

Installation

1. For best results, use your projector in a darkened room.
2. Place the projector on a flat, level surface in a dry area away from dust and moisture.
 To avoid premature lamp failure, do not tilt the front of the projector up or down by more than 75° from level. Tilting the front of the projector up or down from 15° to 75° might reduce lamp life by up to 25%.
3. Do not place your projector in direct sunlight, near heaters or heat radiating appliances.
4. Exposure to direct sunlight, smoke or steam can harm internal components.
5. Handle your projector carefully. Dropping or jarring can damage internal components.
6. Do not place heavy objects on top of the projector.
7. If you wish to have the projector installed on the ceiling:
 - a. Do not attempt to install the projector yourself.
 - b. The projector must be installed by qualified technicians in order to ensure proper operation and reduce the risk of bodily injury.
 - c. In addition, the ceiling must be strong enough to support the projector and the installation must be in accordance with any local building codes.
 - d. Please consult your dealer for more information.

Fire and Shock Precautions

1. Ensure that there is sufficient ventilation and that vents are unobstructed to prevent the build-up of heat inside your projector. Allow at least 4 inches (10 cm) of space between your projector and a wall.
2. Prevent foreign objects such as paper clips and bits of paper from falling into your projector.
Do not attempt to retrieve any objects that might fall into your projector. Do not insert any metal objects such as a wire or screwdriver into your projector. If something should fall into your projector, disconnect it immediately and have the object removed by a qualified Dukane service personnel.
3. Do not place any liquids on top of your projector.
4. Do not look into the lens while the projector is on. Serious damage to your eyes could result.
5. Keep any items such as magnifying glass out of the light path of the projector. The light being projected from the lens is extensive, therefore any kind of abnormal objects that can redirect light coming out of the lens, can cause unpredictable outcome such as fire or injury to the eyes.
6. Do not cover the lens with the supplied lens cap or equivalent while the projector is on. Doing so can lead to melting of the cap and possibly burning your hands due to the heat emitted from the light output.
7. The projector is designed to operate on a power supply of 100-240 V 50/60 Hz AC. Ensure that your power supply fits this requirement before attempting to use your projector.
8. Handle the power cable carefully and avoid excessive bending. A damaged cord can cause electric shock or fire.
9. If the projector is not to be used for an extended period of time, disconnect the plug from the power outlet.
10. Do not touch the power plug during a thunderstorm. Doing so can cause electrical shock or fire.

CAUTION

1. Do not try to touch the ventilation outlet on the front as it can become heated while the projector is turned on.
2. Do not use the tilt-foot for purposes other than originally intended. Misuses such as gripping the tilt-foot or hanging on the wall can cause damage to the projector.
3. Enable High-Speed Fan mode if you continue to use the projector for consecutive days. (From the Advanced menu, select [Projector Options] → [Setup] → [Page 4] → [High Speed Fan Mode].)
4. Do not unplug the power cable from the wall outlet under any one of the following circumstances.
Doing so can cause damage to the projector:
 - * While the Hour Glass icon appears.
 - * While the message "Please wait a moment." appears. This message will be displayed after the projector is turned off.
 - * While the cooling fans are running. (The cooling fans continue to work for 90 seconds after the projector is turned off).
5. Do not eject the PC card or LAN card while its data is being accessed. Doing so can damage your PC card or LAN card data.
6. Do not hold the lens part with your fingers. Doing so could pinch fingers or hands causing injury.

Lamp Replacement

- To replace the lamp, follow all instructions provided on page E-55.
- Be sure to replace the lamp when the message "**The lamp has reached the end of its usable life. Please replace the lamp.**" appears. If you continue to use the lamp after the lamp has reached the end of its usable life, the lamp bulb may shatter, and pieces of glass may be scattered in the lamp case. Do not touch them as the pieces of glass may cause injury.
If this happens, contact your Dukane dealer for lamp replacement.

- Allow a minimum of 90 seconds to elapse after turning off the projector. Then turn off the main power switch, disconnect the power cable and allow 60 minutes to cool the projector before replacing the lamp.

What's in the Box?

Make sure your box contains everything listed. If any pieces are missing, contact your dealer.
Please save the original box and packing materials if you ever need to ship your 8805/8946 Projector.

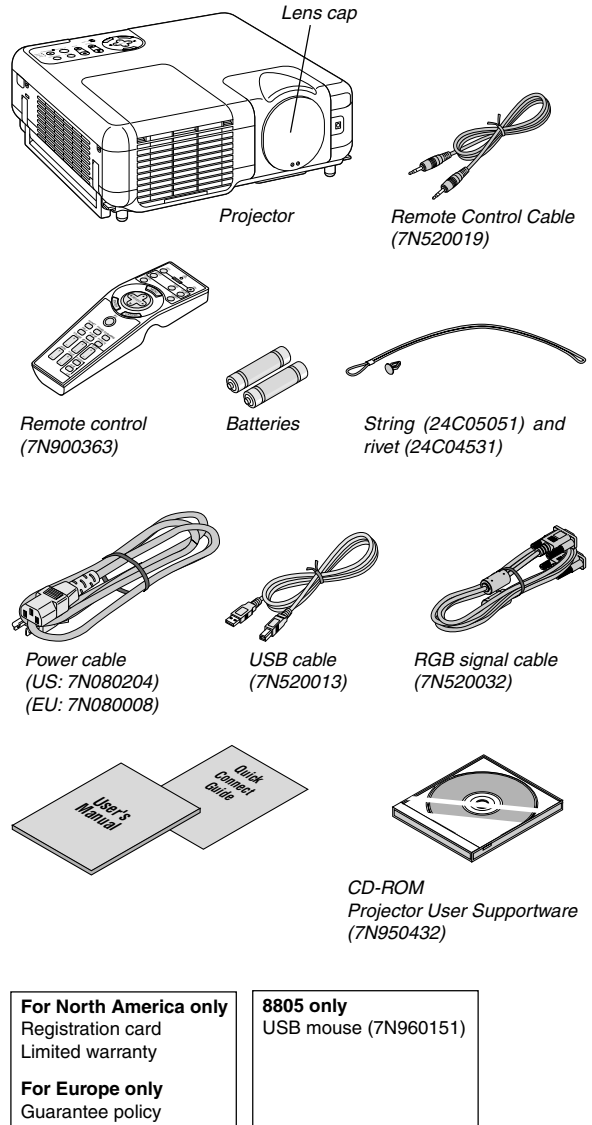

TABLE OF CONTENTS

Important Information	E-2		
Safety Cautions	E-2		
What's in the Box?	E-3		
INTRODUCTION	E-5		
Introduction to the Projector	E-5		
Part Names of the Projector	E-6		
Attaching the lens cap	E-6		
Carrying the Projector	E-6		
Top Features	E-7		
Terminal Panel Features	E-8		
Part Names of the Remote Control	E-9		
Battery Installation	E-11		
Remote Control Precautions	E-11		
Operating Range for Wireless Remote Control	E-11		
Using the Remote Control in Wired Operation	E-11		
INSTALLATION AND CONNECTIONS	E-12		
Setting Up the Screen and the Projector	E-12		
Selecting a Location	E-12		
Throw Distance and Screen Size	E-13		
Making Connections	E-14		
When Viewing a DVI Digital Signal	E-14		
Connecting Your PC or Macintosh Computer	E-14		
To connect SCART output (RGB)	E-15		
Connecting an External Monitor	E-15		
Connecting Your DVD Player	E-16		
Connecting Your VCR or Laser Disc Player	E-17		
Connecting the Supplied Power Cable	E-17		
PROJECTING AN IMAGE (BASIC OPERATION)	E-18		
Turning on the Projector	E-18		
Selecting a Source	E-19		
Adjusting the Picture Size and Position	E-19		
Correcting the Horizontal and Vertical Keystone Distortion (3D Reform)	E-20		
Optimizing RGB Picture Automatically	E-22		
Turning Up or Down Volume	E-22		
Using the Laser Pointer	E-22		
Setting the function switch	E-23		
Turning off the Projector	E-23		
CONVENIENT FEATURES	E-24		
Using the Remote Mouse Function	E-24		
Connecting to your computer for the remote mouse function	E-24		
When using the USB Port	E-24		
Switching operation mode between computer and projector	E-24		
Auto 3D Reform	E-25		
Turning Off the Image and Sound	E-27		
Freezing a Picture	E-27		
Using a Pointer	E-27		
Enlarging and Moving a Picture	E-27		
Getting the On-line Help	E-27		
Using a USB Mouse	E-28		
Using the USB HUB Function	E-28		
Changing Background Logo	E-29		
Making Freehand Drawings on a Projected Image (ChalkBoard)	E-29		
USB Memory Device or USB Memory Card Reader Support	E-29		
USING THE VIEWER	E-30		
Making the Most out of the Viewer Function	E-30		
Operating the Viewer Function from the Projector (playback)	E-31		
Projecting slides (Viewer)	E-31		
Auto Play Mode	E-32		
Switching to Slides Directly from Other Input Modes	E-32		
Viewing Digital Images	E-32		
Storing Images Displayed on the Projector on the PC card (Capture)	E-32		
Deleting Captured Images	E-33		
Using the PC Card Files Function (PC Card Files)	E-33		
USING ON-SCREEN MENU	E-34		
Basic Menu Operation	E-34		
Using the Menus	E-34		
Customizing the Menu	E-34		
Menu tree	E-35		
Menu Elements	E-38		
Entering Alphanumeric Characters by Using the Menu	E-39		
Menu Descriptions & Functions	E-39		
Source Select	E-39		
RGB/Video/S-Video/DVI (DIGITAL)/Viewer/LAN/Entry List	E-40		
Picture	E-40		
Sound	E-40		
Image Options	E-40		
Selecting Aspect Ratio	E-40		
Masking Unwanted Area (Blanking)	E-41		
Adjusting Position and Clock	E-41		
Selecting Resolution	E-41		
Selecting Overscan Percentage	E-41		
Selecting Video Filter Level	E-41		
Selecting Noise Reduction Level	E-41		
Signal Type	E-41		
Picture Management	E-41		
User Adjust (when using User 1 to 4)	E-41		
Selecting Gamma Correction Mode	E-42		
Selecting Color Correction	E-42		
Adjusting Color Temperature and White Balance	E-42		
Selecting Base Setting	E-42		
Projector Options	E-42		
Using 3D Reform	E-42		
Cornerstone	E-42		
Keystone	E-42		
Using Adapting Color Correction	E-43		
Menu [Page1]	E-43		
Selecting Menu Language/Selecting Menu Mode/Customizing the Menu/Selecting Projecting Pointer Icon & Mouse Icon/Selecting Menu Display Time	E-45		
Menu [Page 2]	E-45		
Turning On/Off Source Display / Turning On/Off Message / Selecting Menu Color	E-46		
Setup [Page 1]	E-46		
Selecting Projector Orientation/Selecting a Color or Logo for Background/Setting RGB 1 or 2 for RGB OUT/Setting Closed Caption	E-46		
Setup [Page 2]	E-46		
Setting Viewer Options/Selecting Capture Options/Setting Mouse Button and Sensitivity/Selecting Operation Mode	E-47		
Setup [Page 3]	E-47		
Selecting Signal Format [Signal Select]	E-47		
Setup [Page 4]	E-47		
Enabling Auto Adjust/Enabling Auto Start/Enabling Power Management/Enabling Power Off Confirmation/Enabling Horizontal and Vertical Keystone Correction Save /Enabling High Speed Fan Mode/Selecting Built-in Speakers/Enabling Idle Mode/Resetting the Filter Usage Hours	E-48		
Setup [Page 5]	E-48		
Remote Sensor/S-Video Mode Select	E-48		
Setup [Page 6]	E-48		
Selecting Communication Speed/Selecting Default Source/Disabling the Cabinet Buttons	E-48		
Selecting Lamp Mode and Lamp Type	E-48		
Selecting Aspect Ratio and Position for Screen	E-49		
Selecting Auto Functions	E-49		
Setting LAN Mode	E-50		
IP Address	E-50		
Network Type	E-50		
WEP	E-51		
Mail	E-51		
Status	E-52		
Setting a Password	E-52		
Security	E-53		
Tools	E-54		
Using Sleep Timer/Using Capture/Using PC Card Files/Using ChalkBoard	E-54		
Help	E-54		
Contents	E-54		
Information	E-54		
Returning to Factory Default	E-54		
MAINTENANCE	E-55		
Replacing the Lamp	E-55		
Cleaning	E-56		
Cleaning or Replacing the Filter	E-56		
Cleaning the Cabinet and the Lens	E-56		
TROUBLESHOOTING	E-57		
Power Indicator	E-57		
Status Indicator	E-57		
Lamp Indicator	E-57		
Common Problems & Solutions	E-58		
SPECIFICATIONS	E-60		
APPENDIX	E-62		
Cabinet Dimensions	E-62		
Pin Assignments of D-Sub RGB Input Connector	E-62		
Compatible Input Signal List	E-63		
PC Control Codes and Cable Connection	E-64		
PC Control Connector (D-SUB 9P)	E-64		
Using Software Keyboard	E-64		
Operation Using an HTTP Browser	E-65		
TravelCare Guide	E-66		

INTRODUCTION

Introduction to the Projector

This section introduces you to your new 8805/8946 Projector and describes the features and controls.

Congratulations on Your Purchase of The 8946/8805 Projector

The 8805/8946 is one of the very best projectors available today. The 8805/8946 enables you to project precise images up to 500 inches across (measured diagonally) from your PC or Macintosh computer (desktop or notebook), VCR, DVD player, document camera, a laser disc player or Viewer.

You can use the projector on a tabletop or cart, you can use the projector to project images from behind the screen, and the projector can be permanently mounted on a ceiling*¹. The remote control can be used wirelessly.

*¹ Do not attempt to mount the projector on a ceiling yourself.

The projector must be installed by qualified technicians in order to ensure proper operation and reduce the risk of bodily injury.

In addition, the ceiling must be strong enough to support the projector and the installation must be in accordance with any local building codes. Please consult your dealer for more information.

Features you'll enjoy:

- 3D Reform enhanced keystone correction that allows not only horizontal and vertical access but diagonal adjustments.
- Wireless*² or wired networking access provides easy and effective presentation delivery.

² A wireless LAN card is required. The optional wireless LAN card is available. (SWL-2100N-N)

- Safety protect by Password and Security functions

Password and Security features prevent the projector from being used by unauthorized individuals.

Password prevents unauthorized individuals from changing projector settings or adjustments. Security offers complete protection by using your PC card as a protect key so that the projector will not project a signal without insertion of the registered PC card and unauthorized use can be discouraged.

- Picture Management enables users to adjust individual color settings to their preferences.
- Eco-mode extends lamp life and reduces total cost of ownership. Standard lamp and optional longer life lamp
- Power zoom and power focus standard lens provide easy adjustment.
- Automatic lens focus provides extreme ease of use
- Automatic Wall Color Correction allows for quick adaptive color correction on textured or painted walls and in applications where the display is other than screen material. With the built-in image sensor, the projector adjusts the colors for screen sizes between 40" and 150" diagonally.
- Variable audio out control via projector
- The built-in Viewer allows you to start your presentation even when a PC is not available at the site.
- A high-bright 300 watt DC lamp (240W Eco mode). (8946)
A high-bright 275 watt DC lamp (220W Eco mode). (8805)
- The Standby mode reduces standby power consumption significantly.
- The supplied wireless remote control that operates the projector from any angle.
- The image can be projected between 25 and 500 inches (measured diagonally).
- The "Capture" enables you to capture the current projected image.
- An image can be projected from in front or behind a screen, and the projector can even be installed on the ceiling.

- Exclusive Advanced AccuBlend intelligent pixel blending technology - an extremely accurate image compression technology - offers a crisp image with UXGA (1600×1200) resolution*³.
- Supports most IBM VGA, SVGA, XGA, SXGA/UXGA(with Advanced AccuBlend)*³, Macintosh, component signal (YCbCr/YPbPr) or any other RGB signals within a horizontal frequency range of 24 to 100 kHz and a vertical frequency range of 48 to 120 Hz. This includes NTSC, PAL, PAL-N, PAL-M, PAL60, SECAM and NTSC4.43 standard video signals.

*³ A UXGA (1600×1200) and SXGA (1280×1024) image are displayed with Advanced AccuBlend.

NOTE: Composite video standards are as follows:

NTSC: U.S. TV standard for video in U.S. and Canada.

PAL: TV standard used in Western Europe.

PAL-N: TV standard used in Argentina, Paraguay and Uruguay.

PAL-M: TV standard used in Brazil.

PAL60: TV standard used for NTSC playback on PAL TVs.

SECAM: TV standard used in France and Eastern Europe.

NTSC4.43: TV standard used in Middle East countries.

- The supplied remote control can be used without a cable, and you can even use the remote control to operate your PC's mouse wirelessly from across the room with the built-in remote mouse function.
- You can control the projector with a PC using the PC Control port.
- USB port allows USB mouse operation*⁴.
 - *⁴ The USB ports meet the USB1.1 specification.
- The contemporary cabinet design is light, compact, easy to carry, and complements any office, boardroom or auditorium.
- Nine pointers are available for your presentation.

About this user's manual

The fastest way to get started is to take your time and do everything right the first time. Take a few minutes now to review the user's manual. This may save you time later on. At the beginning of each section of the manual you'll find an overview. If the section doesn't apply, you can skip it.

Part Names of the Projector

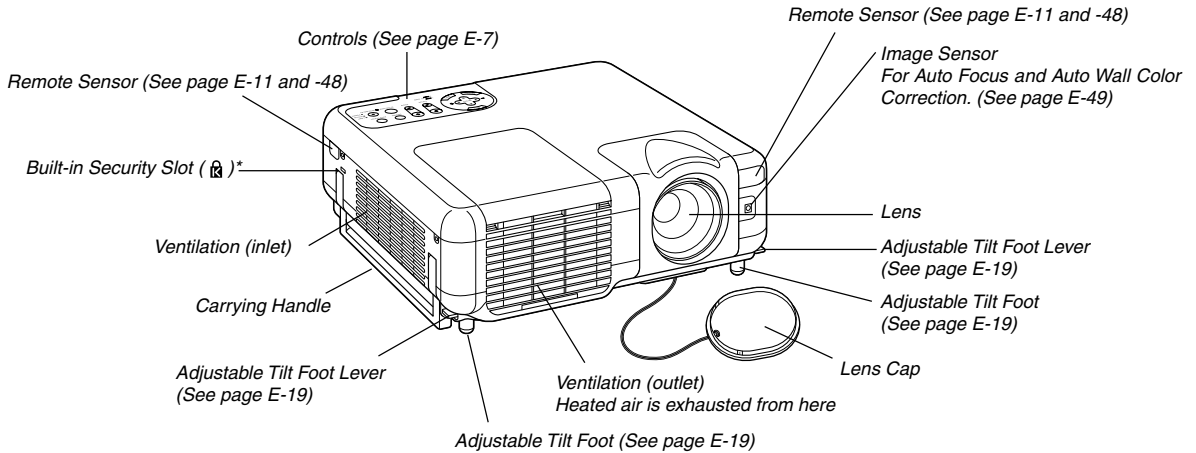

* This security slot supports the MicroSaver® Security System. MicroSaver® is a registered trademark of Kensington Microware Inc. The logo is trademarked and owned by Kensington Microware Inc.

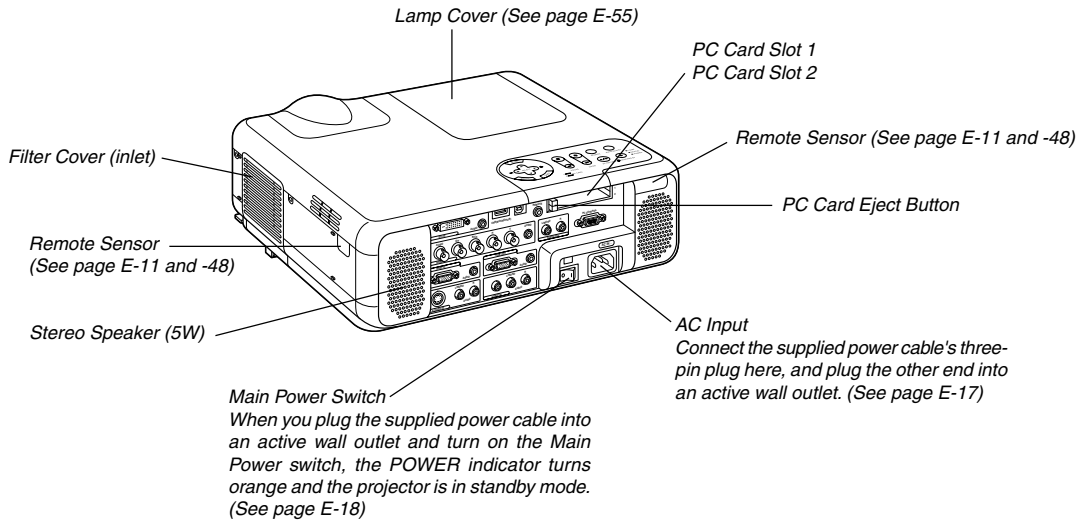

Attaching the lens cap

To attach the lens cap to the bottom with the supplied string and rivet:

1. Thread the string through the hole on the lens cap and then tie a knot in the string.

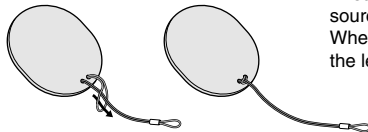

2. Use the rivet to attach the string to the bottom of the projector.

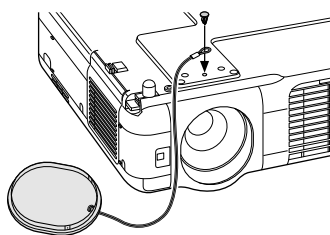

Carrying the Projector

Always carry your projector by the handle.

Ensure that the power cable and any other cables connecting to video sources are disconnected before moving the projector.

When moving the projector or when it is not in use, cover the lens with the lens cap.

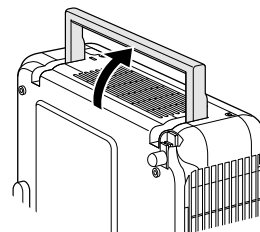

Top Features

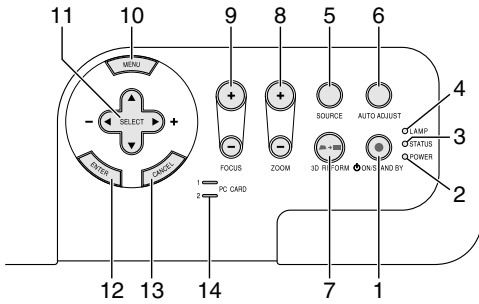

1. POWER Button (ON / STAND BY)(⏻)

Use this button to turn the power on and off when the main power is supplied and the projector is in standby mode.

NOTE: To turn on or off the projector, press and hold this button for a minimum of two seconds.

2. POWER Indicator

When this indicator is green, the projector is on; when this indicator is orange, it is in standby or idle mode. See the Power Indicator section on page E-57 for more details.

3. STATUS Indicator

If this light blinks red rapidly, it indicates that an error has occurred, the lamp cover is not attached properly or the projector has overheated. If this light remains orange, it indicates that you have pressed a cabinet key while the Control Panel Key Lock is enabled. See the Status Indicator section on page E-57 for more details.

4. LAMP Indicator

If this light blinks red rapidly, it's warning you that the lamp has reached the end of its usable life. After this light appears, replace the lamp as soon as possible (See page E-55). If this is lit green continually, it indicates that the lamp mode is set to Eco. See the Lamp Indicator section on page E-57 for more details.

5. SOURCE Button

Use this button to select a video source such as a PC, VCR, DVD player, Viewer (PC card), or LAN. Press and release this button quickly to display the Source List.

Each time this button is pressed for a minimum of ONE second, the input source will change as follows:

RGB1 → RGB2 → Video → S-Video → DVI (DIGITAL) → Viewer → RGB1 → ...

If no input signal is present, the input will be skipped.

6. AUTO ADJUST Button

Use this button to adjust Position-H/V and Pixel Clock/Phase for an optimal picture (See page E-22). Also press and hold this button for a minimum of 2 seconds to enable the Auto Focus or Auto Wall Color Correction function (See page E-49).

7. 3D REFORM Button

Press this button to enter 3D Reform mode to correct the keystone (trapezoidal) distortion, and make the image square.

8. ZOOM Button (+/-)

Zoom the lens in and out.

9. FOCUS Button (+/-)

Adjust the lens focus.

10. MENU Button

Displays the menu.

11. SELECT ▲▼◀▶ (+) (-) / Volume Buttons

▲▼ : Use these buttons to select the menu of the item you wish to adjust. When no menus appear, these buttons work as a volume control.

◀▶ : Use these buttons to change the level of a selected menu item. A press of the ▶ button executes the selection. When the menus or the Viewer tool bar is not displayed, these buttons can be used to select a slide, or to move the cursor in Folder List or Slide List.

When the pointer is displayed, these ▲▼◀▶ buttons move the pointer.

12. ENTER Button

Executes your menu selection and activates items selected from the menu.

13. CANCEL Button

Press this button to exit "Menus". Press this button to return the adjustments to the last condition while you are in the adjustment or setting menu.

14. PC CARD Access Indicator 1/2

Lights while accessing a PC card.

Terminal Panel Features

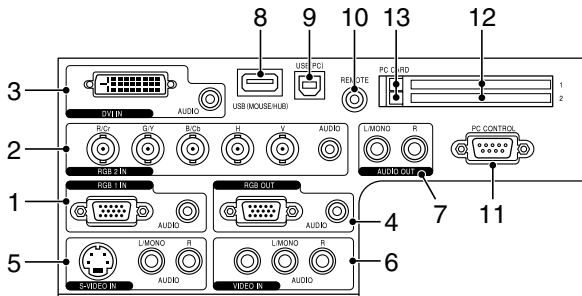

- RGB1 IN / Component Input Connector (Mini D-Sub 15 Pin)**
 Connect your computer or other analog RGB equipment such as IBM compatible or Macintosh computers. Use the supplied RGB cable to connect to your computer. This also serves as a component input connector that allows you to connect a component video output of component equipment such as a DVD player. This connector also supports SCART output signal. See page E-15 for more details.

RGB1 AUDIO Input Mini Jack (Stereo Mini)

This is where you connect the audio output from your computer or DVD player when connected to the RGB1 input. A commercially available audio cable is required.

- RGB2 IN / Component Input Connectors (BNC)**
 Connect R,G,B,H (Horizontal sync) and V (Vertical sync) outputs of external equipment.

If using a component with a combined sync (SYNC) output, connect it to the H/V terminal.

When using luminance and color-difference signals of HDTV and DVD, connect Pr/Cr to the R,Y to the G and Pb/Cb to the B input of the projector.

NOTE: The RGB IN 2 does not support Plug & Play.

RGB2 AUDIO IN Mini Jack (Stereo Mini)

This is where you connect audio output from your computer or DVD player connected to the RGB2 input. A commercially available audio cable is required.

- DVI IN Connector (24 pin)**
 This connector can be used to accept a digital signal output from a computer or other sources with a DVI connector.

DVI AUDIO Input Mini Jack (Stereo Mini)

This is where you connect the audio output from your computer when connected to the DVI input. A commercially available audio cable is required.

- RGB OUT Connector (Mini D-Sub 15 Pin)**
 You can use this connector to loop your computer image to an external monitor from the RGB 1 or 2 input source.
 The RGB analog signal set on RGBOUT Terminal is output during idle mode. See pages E-15 and -46.

RGB AUDIO OUT Mini Jack (Stereo Mini)

Connect an additional audio equipment here to listen to audio coming from your computer connected to RGB1, RGB2 or DVI input. Note that there is no audio output from this jack during Standby and Idle.

- S-VIDEO IN Connector (Mini DIN 4 Pin)**
 Here is where you connect the S-Video input from an external source like a VCR.

NOTE: S-Video provides more vivid color and higher resolution than the traditional composite video format.

S-VIDEO AUDIO Input Jacks R/L (RCA)

These are your left and right channel audio inputs for stereo sound from an S-Video source.

- VIDEO IN Connector (RCA)**
 Connect a VCR, DVD player, laser disc player, or document camera here to project video.

VIDEO AUDIO Input Jacks R/L (RCA)

These are your left and right channel audio inputs for stereo sound from a Video source.

- AUDIO OUT Jacks R/L (RCA)**
 You can use this connector to output sound from the currently selected input source (RGB 1, RGB 2, DVI (DIGITAL), Video or S-Video). Output sound level can be adjusted in accordance with the sound level of the internal speaker.

- USB Port (MOUSE/HUB) [Type A]**
 Connect a USB mouse. You can operate the menu or Viewer with the USB mouse via this port.
 - A USB-supported scanner or PC peripheral can be connected to this port. (USB Hub Function)

- USB Port (PC) [Type B]**
 Connect this port to the USB port (type A) of your PC using the supplied USB cable. You can operate your computer's mouse functions from the remote control. This port also serves as a PC Control port by using Dynamic Image Utility 2.0 included on the supplied CD-ROM.

- REMOTE (Mini Jack)**
 Connect your remote control cable here for wired operation.

- PC CONTROL Port (D-Sub 9 Pin)**
 Use this port to connect your PC to control your projector via a serial cable. This enables you to use your PC and serial communication protocol to control the projector. A commercially available RS232C cross cable is required to use this port. You can also control the projector by using Dynamic Image Utility 2.0 included on the supplied CD-ROM.

To do so you must first have Dynamic Image Utility 2.0 installed on your PC. If you are writing your own program, typical PC control codes are on page E-64.

- PC CARD Slot 1/2**
 Insert a PC card, commercially available LAN card or optional wireless LAN card here.
 There are two slots: Slot 1 and Slot 2.

NOTE: A dummy card is inserted into each slot at the time of shipment. First remove the dummy cards before use.

- PC CARD Eject Button 1/2**
 Press to eject a PC card partially. Each slot has its own eject button: 1 and 2.

Part Names of the Remote Control

NOTE: If you are using a Macintosh computer, you can click either the right-click or left-click button to activate the mouse.

1. Infrared Transmitter

Direct the remote control toward the remote sensor on the projector cabinet.

2. LASER Pointer

Beams a laser light when the LASER button is pressed.

3. Remote Jack

Connect your remote control cable here for wired operation.

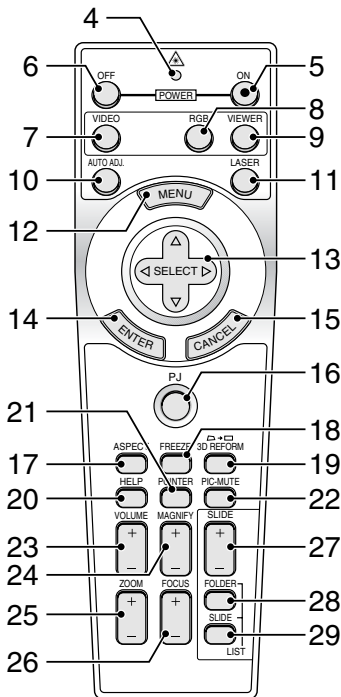
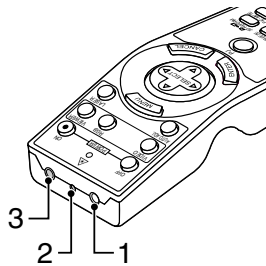

4. LED

Flashes when any button is pressed.

5. POWER ON Button

When the main power is on, you can use this button to turn your projector on.

NOTE: To turn on the projector, press and hold the POWER ON button for a minimum of two seconds.

6. POWER OFF Button

You can use this button to turn your projector off.

NOTE: To turn off the projector, press and hold the POWER OFF button for a minimum of two seconds.

7. VIDEO Button

Press this button to toggle between Video and S-Video inputs.

8. RGB Button

Press this button to select RGB 1, RGB 2 or DVI (DIGITAL) inputs. Each time this button is pressed, the input source will change as follows:

RGB 1 → RGB 2 → DVI (DIGITAL) → RGB 1 → ...

9. VIEWER Button

Press this button to select the Viewer source.

10. AUTO ADJ Button

Use this button to adjust an RGB source for an optimal picture. Also press and hold this button for a minimum of 2 seconds to enable the Auto Focus or Auto Wall Color Correction function. See page E-20 or -22.

11. LASER Button

Press and hold this button to activate the laser pointer. When lit, you can use the laser to draw your audience's attention to a red dot that you can place on any object.

12. MENU Button

Displays the menu for various settings and adjustments.

13. SELECT ▲▼◀▶ (Mouse) Button

When you are in the Computer mode, these buttons work as a computer mouse.

When you are in the Projector mode, which is indicated by lighting the PJ button. See page E-24.

▲▼ : Use these buttons to select the menu of the item you wish to adjust.

◀▶ : Use these buttons to change the level of a selected menu item. A press of the ▶ button executes the selection.

When the pointer is displayed, these ▲▼◀▶ buttons move the pointer. When the pointer is not displayed, these ▲▼◀▶ buttons are for adjusting the image.

14. ENTER (Left Click) Button

When you are in the Computer mode, this button works as the mouse left button. When this button is pressed and held for a minimum of 2 seconds, the drag mode is set. When you are in the Projector mode, which is indicated by lighting the PJ button: Use this button to enter your menu selection. It works the same way as the ENTER button on the cabinet. See page E-7.

15. CANCEL (Right Click) Button

When you are in the Computer mode, this button works as the mouse right button. When you are in the Projector mode, which is indicated by lighting the PJ button: Press this button to exit the Menus. It works the same way as the CANCEL button on the cabinet. See page E-7.

16. PJ Button

Press this button to switch the SELECT, CANCEL, and ENTER buttons between the Projector mode (lit red) and the Computer mode. Press this button or any one of the POWER ON/OFF, MENU, ASPECT, 3D REFORM, HELP, POINTER, MAGNIFY, VIEWER, FOLDER LIST or SLIDE LIST buttons to switch to the Projector mode and the PJ button lights red. To switch back to the Computer mode, press the PJ button again. See page E-24.

17. ASPECT Button

Press this button to display the Aspect Ratio select screen. See page E-40.

18. FREEZE Button

This button will freeze a picture. Press again to resume motion.

19. 3D REFORM Button

Press this button to enter 3D Reform to correct the keystone (trapezoidal) distortion, and make the image square. See page E-20.

20. HELP Button

Provides the online help or the set information.

21. POINTER Button

Press this button to display one of the nine pointers; press again to hide the pointer. You can move your pointer icon to the area you want on the screen using the Select ▲▼◀▶ button. See page E-27.

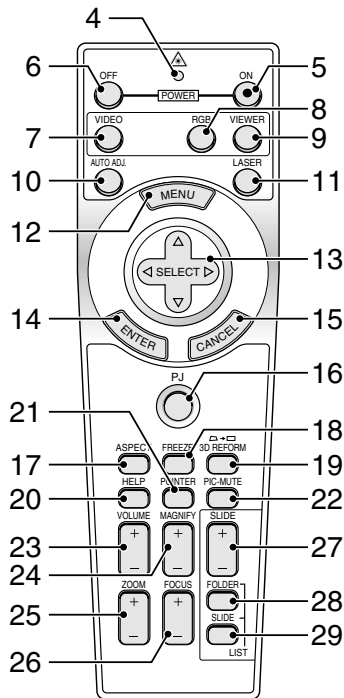

22. PICTURE MUTE Button

This button turns off the image and sound for a short period of time. Press again to restore the image and sound.

NOTE: When the menu is displayed, a press of this button mutes an image and sound without turning off the menu.

23. VOLUME (+)(-) Button

Press (+) to increase the volume and (-) to decrease it.

24. MAGNIFY (+)(-) Button

Use this button to adjust the image size up to 400%. When the pointer is displayed, the image is magnified about the center of the pointer. When the image is magnified, the pointer is changed to the magnifying icon.

When the pointer is not displayed, the image is magnified about the center of the screen. See page E-27.

25. ZOOM (+)(-) Button

Zoom the lens in and out.

26. FOCUS (+)(-) Button

Adjust the lens focus.

27. SLIDE (+)(-) Button

Press (+) to select the next folder or slide and (-) to select the previous folder or slide. See page E-31.

28. FOLDER LIST Button

Press this button to select Viewer source to display a list of folders included in a PC card. See page E-31.

29. SLIDE LIST Button

Press this button to select Viewer source to display a list of slides included in a PC card. See page E-31.

NOTE: The default is the Computer mode, which allows you to use the SELECT, CANCEL, and ENTER buttons as your computer mouse. When the POWER ON/OFF, MENU, ASPECT, 3D REFORM, HELP, POINTER, MAGNIFY, VIEWER, FOLDER LIST, or SLIDE LIST button is pressed, the P.J button lights red to indicate that you are in the Projector mode. If no buttons are pressed within 60 seconds, the light goes out and the Projector mode is canceled.

Battery Installation

1. Press firmly and slide the battery cover off.

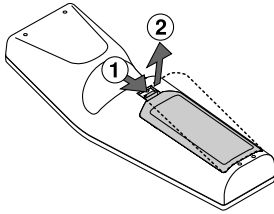

2. Remove both old batteries and install new ones (AA). Ensure that you have the batteries' polarity (+/-) aligned correctly.

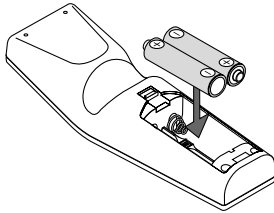

3. Slip the cover back over the batteries until it snaps into place. Do not mix different types of batteries or new and old batteries.

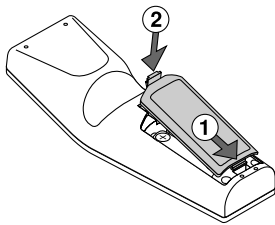

Note on Remote Control Operation:

If you press and hold the SELECT $\blacktriangle\blacktriangledown\blacktriangleleft\blacktriangleright$ button while installing new batteries, the remote control may fail to work properly. Should this happen, remove the batteries and then install them again without touching the SELECT button.

Remote Control Precautions

- Handle the remote control carefully.
- If the remote control gets wet, wipe it dry immediately.
- Avoid excessive heat and humidity.
- If you will not be using the remote control for a long time, remove the batteries.
- Do not place the batteries upside down.
- Do not use new and old batteries together, or use different types of batteries together

Operating Range for Wireless Remote Control

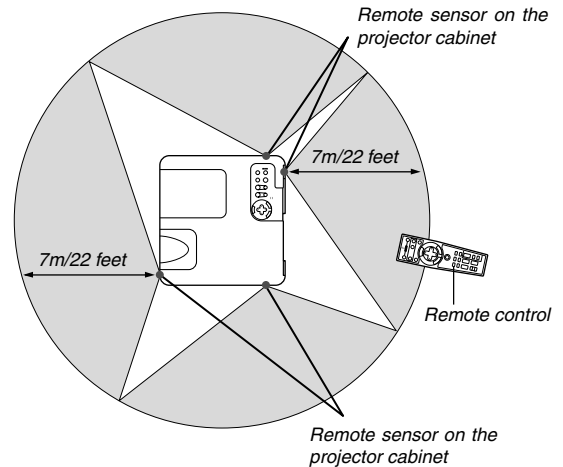

- The infrared signal operates by line-of-sight up to a distance of about 22 feet/7 m and within a 60-degree angle of the remote sensor on the projector cabinet.
- The projector will not respond if there are objects between the remote control and the sensor, or if strong light falls on the sensor. Weak batteries will also prevent the remote control from properly operating the projector.

Using the Remote Control in Wired Operation

Connect one end of the supplied remote cable to the REMOTE mini jack and the other end to the remote jack on the remote control.

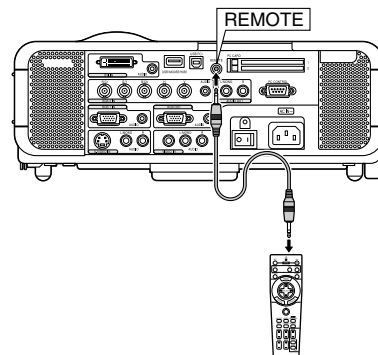

INSTALLATION AND CONNECTIONS

This section describes how to set up your projector and how to connect video and audio sources.

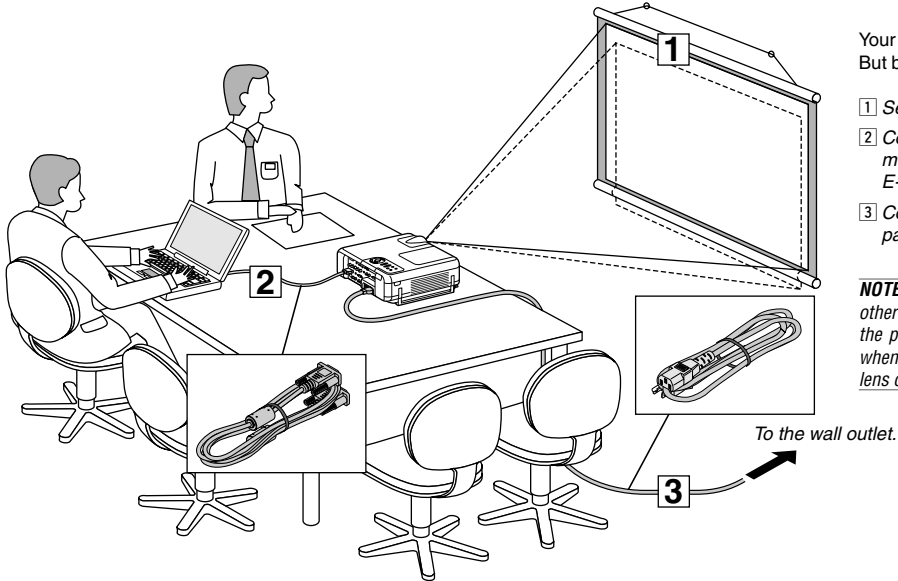

Setting Up the Screen and the Projector

Selecting a Location

The further your projector is from the screen or wall, the larger the image. The minimum size the image can be is approximately 25" (0.64 m) measured diagonally when the projector is roughly 39.4 inches (1.0 m) from the wall or screen. The largest the image can be is 500" (12.7 m) when the projector is about 614.2 inches (15.6 m) from the wall or screen. Use the drawing below as a guide.

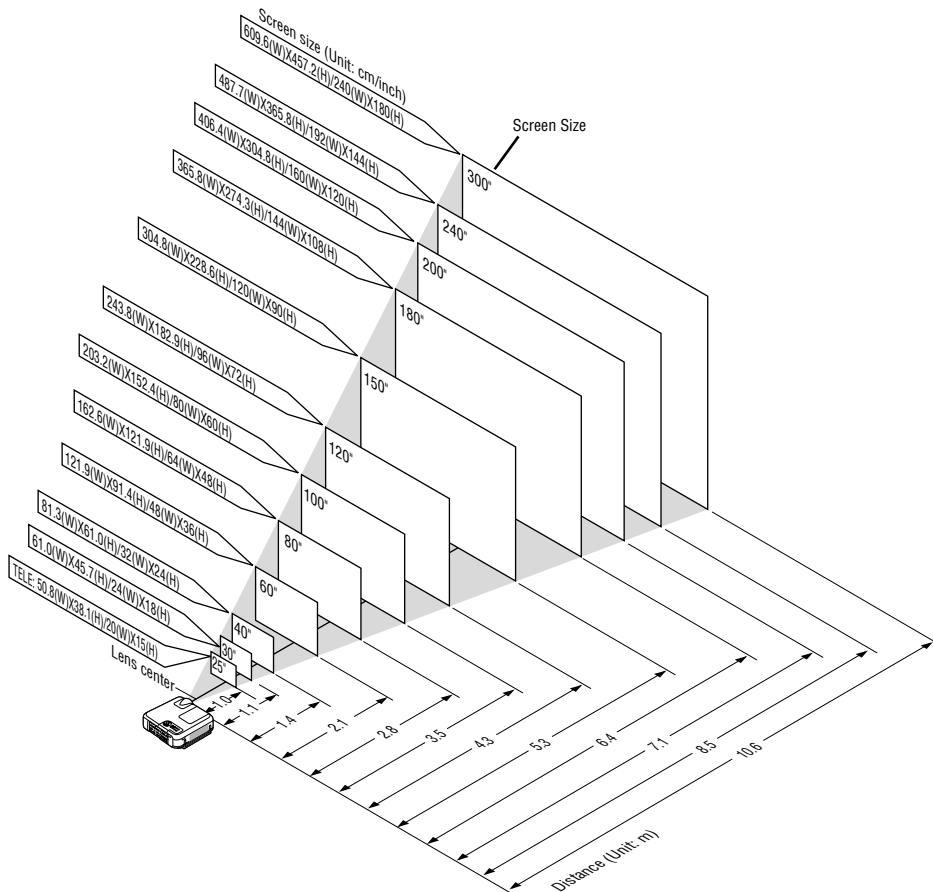

Throw Distance and Screen Size

The following shows the proper relative positions of the projector and screen. Refer to the table to determine the position of installation.

Distance Chart

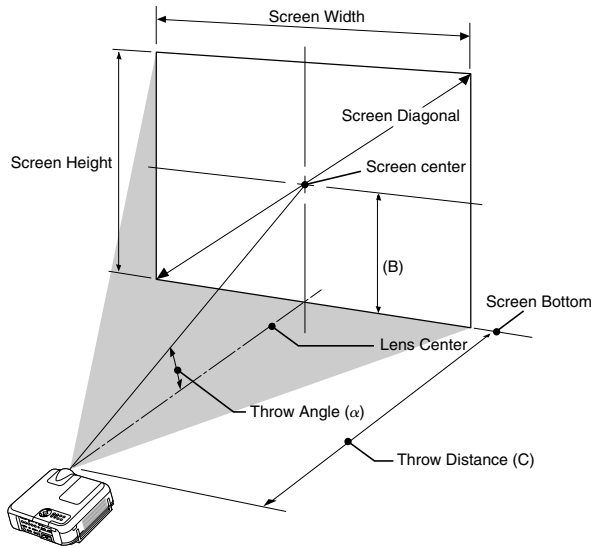

B = Vertical distance between lens center and screen center

C = Throw distance

α = Throw angle

NOTE: Distances may vary +/-5%.

Screen Size			B	C	α
Diagonal	Width	Height			
inch	inch	inch	inch	inch	degree
25	20	15	8.0	— - 39.6	— - 10.7
30	24	18	9.0	35.1 - 47.8	14.4 - 10.7
40	32	24	12.0	47.4 - 64.4	14.2 - 10.5
60	48	36	18.0	72.1 - 97.6	14.0 - 10.4
67	54	40	20.0	80.7 - 109.2	14.0 - 10.4
72	58	43	22.0	86.9 - 117.5	14.0 - 10.4
80	64	48	24.0	96.8 - 130.8	13.9 - 10.4
84	67	50	25.0	101.7 - 137.4	13.9 - 10.4
90	72	54	27.0	109.1 - 147.4	13.9 - 10.4
100	80	60	30.0	121.4 - 164.0	13.9 - 10.4
120	96	72	36.0	146.1 - 197.2	13.8 - 10.3
150	120	90	45.0	183.1 - 246.9	13.8 - 10.3
180	144	108	54.0	220.1 - 296.7	13.8 - 10.3
200	160	120	60.0	244.8 - 329.9	13.8 - 10.3
210	168	126	63.0	257.1 - 346.5	13.8 - 10.3
240	192	144	72.0	294.1 - 396.3	13.8 - 10.3
261	209	157	78.0	320.0 - 431.1	13.7 - 10.3
270	216	162	81.0	331.1 - 446.0	13.7 - 10.3
300	240	180	90.0	368.1 - 495.8	13.7 - 10.3
350	280	210	105.0	429.8 - 578.7	13.7 - 10.3
400	320	240	120.0	491.5 - —	13.7 - —
450	360	270	135.0	553.2 - —	13.7 - —
500	400	300	150.0	614.8 - —	13.7 - —

Screen Size			B	C	α
Diagonal	Width	Height			
mm	mm	mm	mm	mm	degree
635	508	381	191	— - 1005	— - 10.7
762	610	457	229	891 - 1215	14.4 - 10.7
1016	813	610	305	1204 - 1636	14.2 - 10.5
1524	1219	914	457	1831 - 2479	14.0 - 10.4
1702	1361	1021	511	2050 - 2774	14.0 - 10.4
1829	1463	1097	549	2207 - 2985	14.0 - 10.4
2032	1626	1219	610	2458 - 3322	13.9 - 10.4
2134	1707	1280	640	2583 - 3490	13.9 - 10.4
2286	1829	1372	686	2771 - 3743	13.9 - 10.4
2540	2032	1524	762	3084 - 4165	13.9 - 10.4
3048	2438	1829	914	3711 - 5007	13.8 - 10.3
3810	3048	2286	1143	4651 - 6272	13.8 - 10.3
4572	3658	2743	1372	5591 - 7536	13.8 - 10.3
5080	4064	3048	1524	6217 - 8379	13.8 - 10.3
5334	4267	3200	1600	6531 - 8800	13.8 - 10.3
6096	4877	3658	1829	7471 - 10064	13.8 - 10.3
6629	5304	3978	1989	8129 - 10949	13.7 - 10.3
6858	5486	4115	2057	8410 - 11328	13.7 - 10.3
7620	6096	4572	2286	9350 - 12593	13.7 - 10.3
8890	7112	5334	2667	10917 - 14700	13.7 - 10.3
10160	8128	6096	3048	12484 - —	13.7 - —
11430	9144	6858	3429	14050 - —	13.7 - —
12700	10160	7620	3810	15617 - —	13.7 - —

WARNING

- * **Installing your projector on the ceiling must be done by a qualified technician. Contact your Dukane dealer for more information.**
- * **Do not attempt to install the projector yourself.**
- To avoid premature lamp failure, do not tilt the front of the projector up or down by more than 75° from level. Tilting the front of the projector up or down from 15° to 75° might reduce lamp life by up to 25%.
- Only use your projector on a solid, level surface. If the projector falls to the ground, you can be injured and the projector severely damaged.
- Do not use the projector where temperatures vary greatly. The projector must be used at temperatures between 32°F (0°C) and 95°F (35°C).
- Do not expose the projector to moisture, dust, or smoke. This will harm the screen image.
- Ensure that you have adequate ventilation around your projector so heat can dissipate. Do not cover the vents on the side or the front of the projector.

Reflecting the Image

Using a mirror to reflect your projector's image enables you to enjoy a much larger image. Contact your Dukane dealer if you need a mirror. If you're using a mirror and your image is inverted, use the MENU and SELECT buttons on your projector cabinet or ▲▼ buttons on your remote control to correct the orientation. (See page E-46.)

Making Connections

NOTE: When using with a notebook PC, be sure to connect between the projector and the notebook PC before turning on the power to the notebook PC. In most cases signal cannot be output from RGB output unless the notebook PC is turned on after connecting with the projector.

* If the screen goes blank while using your remote control, it may be the result of the computer's screen-saver or power management software.

* If you accidentally hit the POWER button on the remote control, wait 90 seconds and then press the POWER button again to resume.

When Viewing a DVI Digital Signal:

To project a DVI digital signal, be sure to connect the PC and the projector using a DVI-D signal cable (not supplied) before turning on your PC or projector. Turn on the projector first and select DVI (DIGITAL) from the source menu before turning on your PC.

Failure to do so may not activate the digital output of the graphics card resulting in no picture being displayed. Should this happen, restart your PC. Do not disconnect the DVI-D signal cable while the projector is running. If the signal cable has been disconnected and then re-connected, an image may not be correctly displayed. Should this happen, restart your PC.

NOTE:

- Use the DVI-D cable compliant with DDWG (Digital Display Working Group) DVI (Digital Visual Interface) revision 1.0 standard. The DVI-D cable should be within 5 m (196") long.
- The DVI (DIGITAL) connector accepts VGA (640x480), SVGA (800x600), 1152x864, XGA (1024x768) and SXGA (1280x1024 @ up to 60Hz).

Connecting Your PC or Macintosh Computer

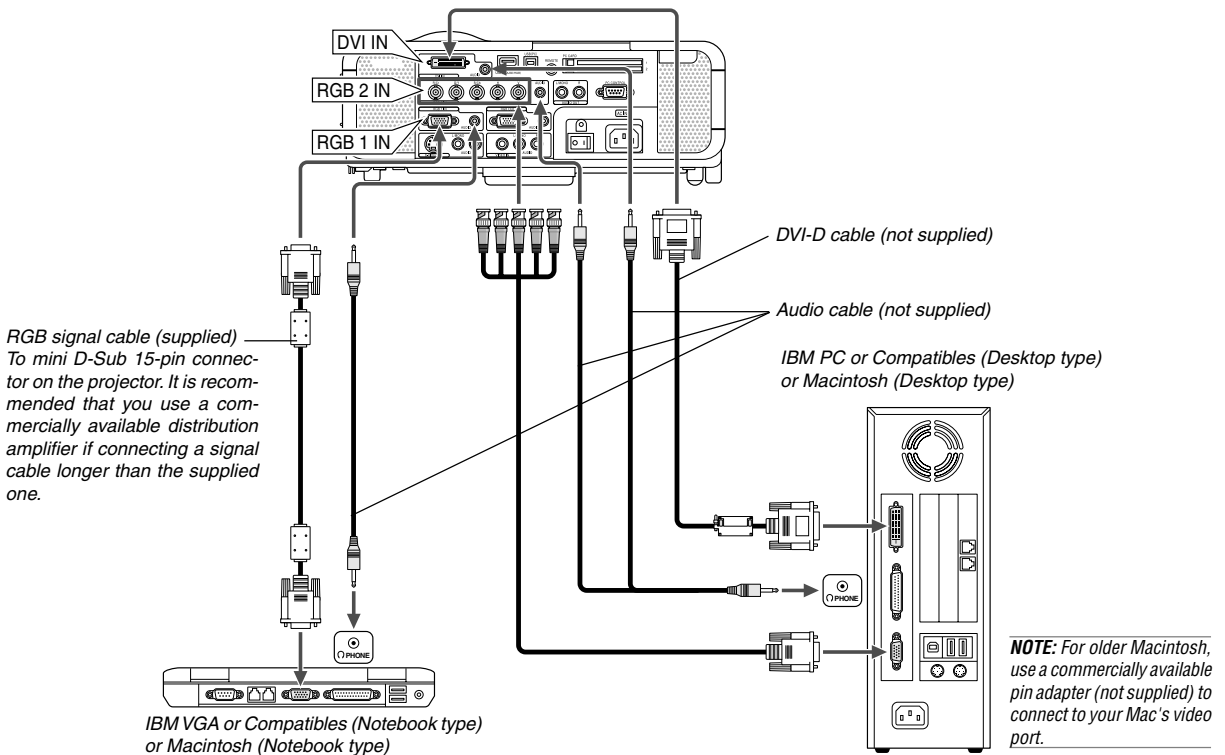

Connecting your PC or Macintosh computer to your projector will enable you to project your computer's screen image for an impressive presentation.

To connect to a PC or Macintosh, simply:

1. Turn off the power to your projector and computer.
2. Use the supplied signal cable to connect your PC or Macintosh to the projector.
3. Turn on the projector and the computer.
4. If the projector goes blank after a period of inactivity, it may be caused by a screen saver installed on the computer you've connected to the projector.

Connecting to RGB 2 IN connectors

Use a BNC × 5 cable to connect your PC and the RGB 2 IN connectors on your projector.

Connecting Your PC with a DVI Connector

Use a DVI-D signal cable (not supplied) to connect a DVI connector of your PC to the projector.

NOTE: The 8805/8946 is not compatible with video decoded outputs of Dukane 8805/8946

To connect SCART output (RGB)

Before connections: An exclusive SCART adapter (ADP-SC1) and a commercially available SCART cable are required for this connection.

NOTE:

- Audio signal is not available for this connection.
- The RGB IN 2 connector does not support Plug & Play.

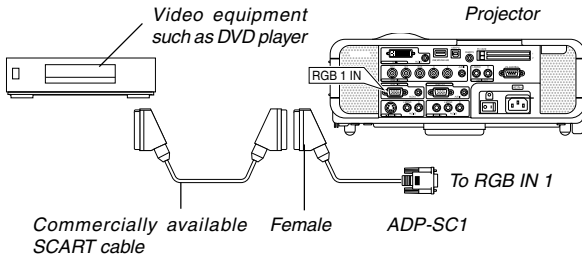

1. Turn off the power to the projector and your video equipment.
2. Use the ADP-SC1 SCART adapter and a commercially available SCART cable to connect the RGB 1 input of your projector and a SCART output (RGB) of your video equipment.
3. Turn on the power to the projector and your video equipment.
4. Use the RGB 1 button on the remote control to select the RGB 1 input.
5. Press the MENU button on the remote control to display the menu.
6. From the Advanced menu, select [Projector Options] → [Setup] → [Page 3] → [Signal Select RGB1] → [Scart].
SCART is a standard European audio-visual connector for TVs, VCRs and DVD players. It is also referred to as Euro-connector.

NOTE: The ADP-SC1 SCART adapter is obtainable from Dukane. Contact your Dukane.

Connecting an External Monitor

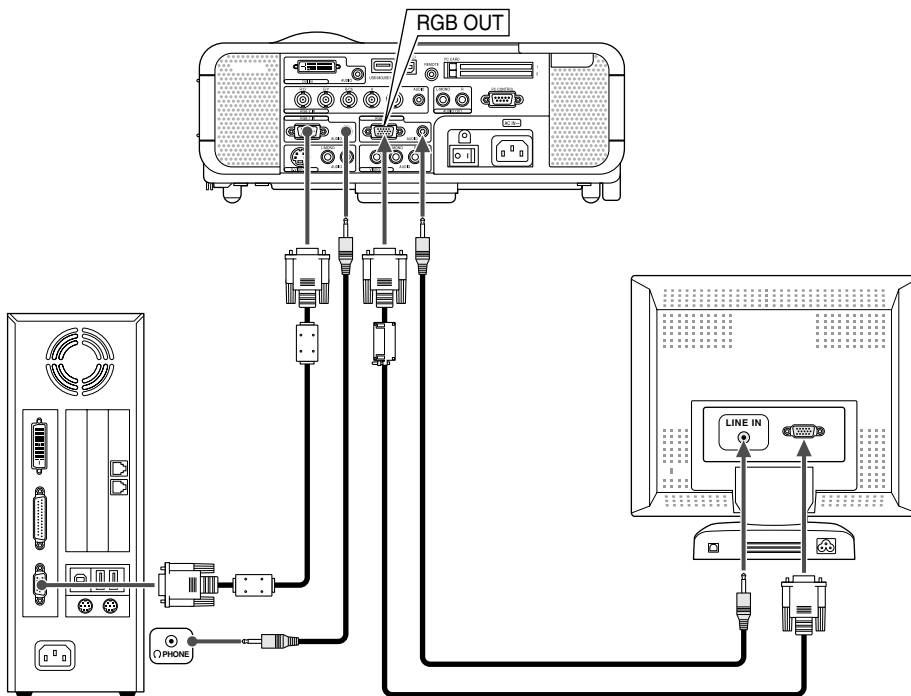

You can connect a separate, external monitor to your projector to simultaneously view on a monitor the RGB analog image you're projecting. To do so:

1. Turn off the power to your projector, monitor and computer.
2. Use a 15-pin cable to connect your monitor to the RGB OUT (Mini D-Sub 15 pin) connector on your projector.
3. Turn on the projector, monitor and the computer.

NOTE:

- The RGB OUT connector outputs RGB signal during idle mode (See page E-47). When the projector goes into idle mode, the image on an external monitor disappears for a moment. Note that the RGB OUT connector will not output RGB signal during Standby mode.
- When the projector is in the Idle mode, the image may not be correctly displayed while the cooling fans are running immediately after turning on or off the power. Note that the RGB OUT connector will not output RGB signal during Standby mode.
- Daisy chain connection is not possible.

Connecting Your DVD Player

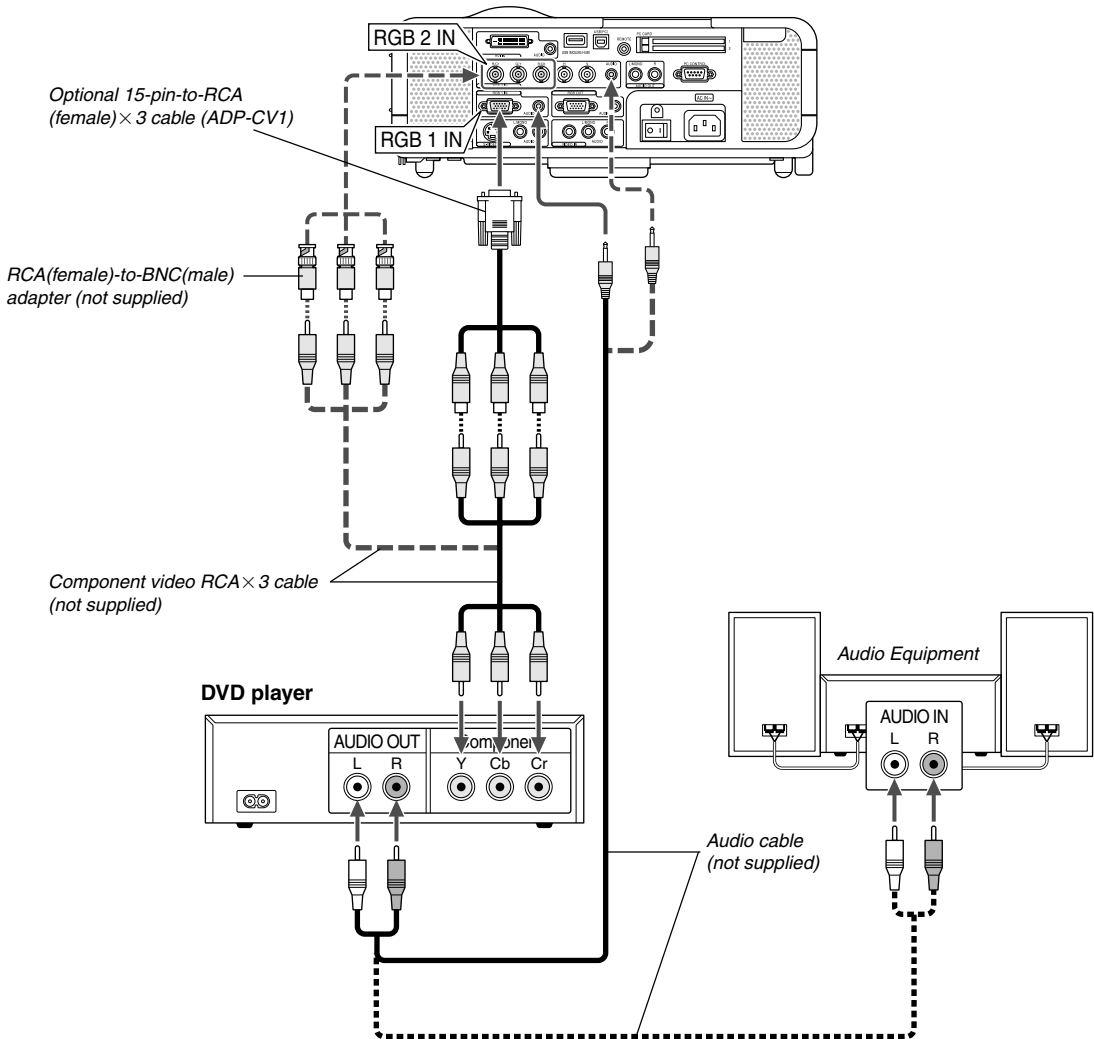

You can connect your projector to a DVD player with component output or Video output. To do so, simply:

1. Turn off the power to your projector and DVD player.
2. If your DVD player has the component video (Y,Cb,Cr) output, use a commercially available component video cable (RCAX3) and the optional 15-pin-to-RCA (female) × 3 cable to connect your DVD player to the RGB IN1 or IN2 connector on the projector.

For a DVD player without component video (Y,Cb,Cr) output, use common RCA cables (not provided) to connect a composite VIDEO output of the DVD player to the Video Input of the projector.

3. Turn on the projector and DVD player.

NOTE: Refer to your DVD player's owner's manual for more information about your DVD player's video output requirements.

Connecting Your VCR or Laser Disc Player

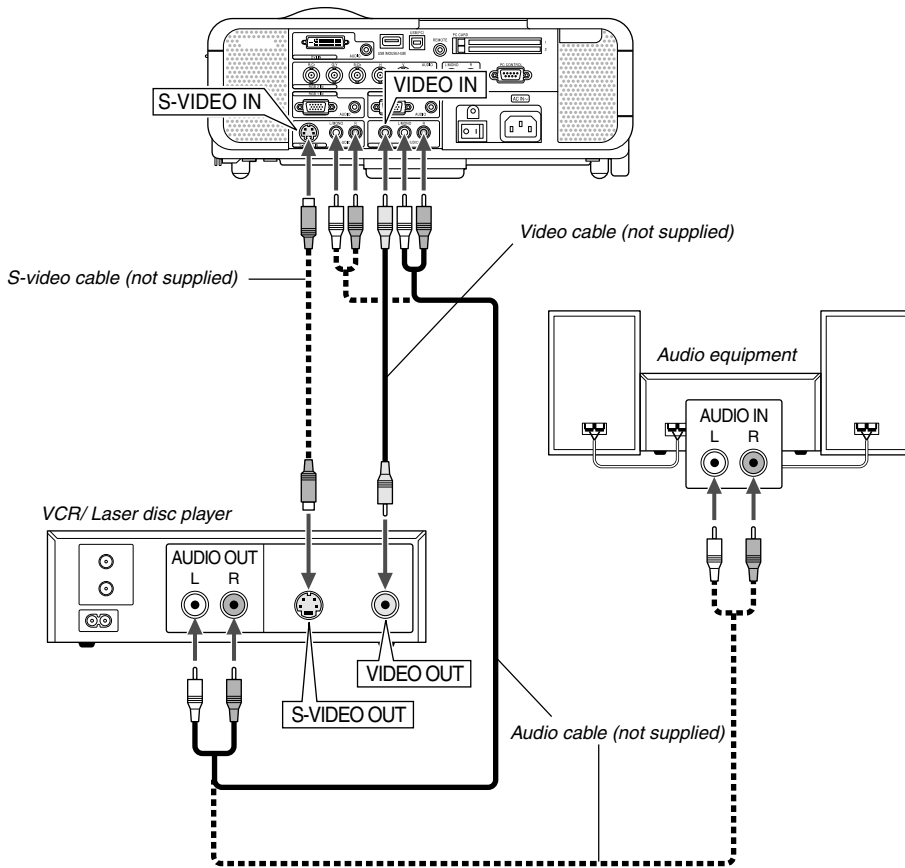

Use common RCA cables (not provided) to connect your VCR, laser disc player or document camera to your projector.

To make these connections, simply:

1. Turn off the power to the projector and VCR, laser disc player or document camera.
2. Connect one end of your RCA cable to the video output connector on the back of your VCR or laser disc player, connect the other end to the Video input on your projector. Use an audio cable (not supplied) to connect the audio from your VCR or laser disc player to your audio equipment (if your VCR or laser disc player has this capability). Be careful to keep your right and left channel connections correct for stereo sound.
3. Turn on the projector and the VCR or laser disc player.

NOTE: Refer to your VCR or laser disc player owner's manual for more information about your equipment's video output requirements.

NOTE: An image may not be displayed correctly when a Video or S-Video source is played back in fast-forward or fast-rewind via a scan converter.

Connecting the Supplied Power Cable

Connect the supplied power cable to the projector. First connect the supplied power cable's three-pin plug to the AC IN of the projector, and then connect the other plug of the supplied power cable in the wall outlet.

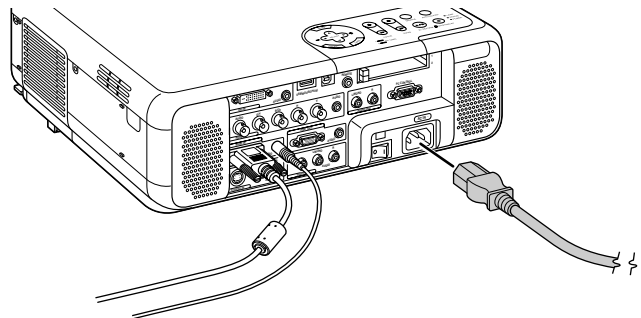

PROJECTING AN IMAGE (BASIC OPERATION)

This section describes how to turn on the projector and to project a picture onto the screen.

Turning on the Projector

NOTE:

- When plugging in or unplugging the supplied power cable, make sure that the main power switch is pushed to the off(O) position. Failure to do so may cause damage to the projector.
- The projector has two power switches: main power switch and POWER button (POWER ON and OFF on the remote control)
- The projector has a feature to prevent itself from being used by unauthorized individuals. To use this feature, register your PC card as a protect key. See "Security" in "Projector Options" on page E-53 for more details.

To turn on the main power to the projector, press the Main Power switch to the ON position (I).

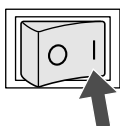

Before you turn on your projector, ensure that the computer or video source is turned on and that your lens cap is removed.

Only after you press the ON/STAND BY button on the projector cabinet or POWER ON button on the remote control for a minimum of 2 seconds will the power indicator turn to green and the projector become ready to use.

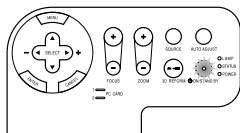

Note on Startup screen (Menu Language Select screen)

When you first turn on the projector, you will get the Startup screen. This screen gives you the opportunity to select one of the seven menu languages: English, German, French, Italian, Spanish, Swedish and Japanese.

To select a menu language, follow these steps:

1. Use the SELECT ▲ or ▼ button to select one of the seven languages for the menu.

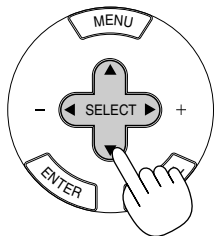

2. Press the ENTER button to execute the selection.

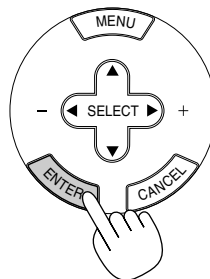

3. The Basic menu will be displayed in the language you have selected.

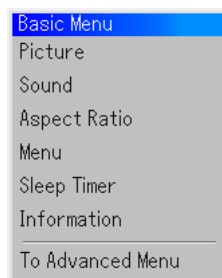

To close the menu, press the CANCEL button.

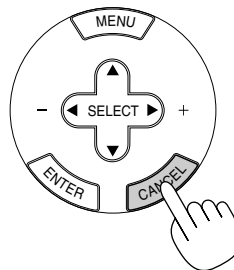

After this has been done, you can proceed to the advanced menu operation.

If you want, you can select the menu language later. See "Language" on page E-45.

NOTE: To turn the projector on by plugging in the power cable, first turn on the Main Power switch to ON and use the menu and enable the "Auto Start" feature. (See page E-47.) Immediately after turning on the projector, screen flicker may occur. This is not a fault. Wait 3 to 5 minutes until the lamp lighting is stabilized.

When the Lamp mode is set to Eco, the Lamp indicator will light green. If one of the following things happens, the projector will not turn on.

- * If the internal temperature of the projector is too high, the projector detects abnormal high temperature. In this condition the projector will not turn on to protect the internal system. If this happens, wait for the projector's internal components to cool down.
- * When the lamp reaches its end of usable life, the projector will not turn on. If this happens, replace the lamp.
- * If the lamp fails to light, and if the STATUS indicator flashes on and off in a cycle of six times, wait a full minute and then turn on the power.

Selecting a Source

Selecting the computer or video source

Using the Remote Control



Press any one of the RGB, VIDEO or VIEWER buttons.

NOTE: If no input signal is available, the projector will display a blue background (factory preset).

Selecting from Source List

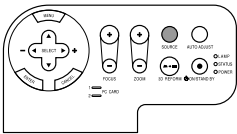

Source List



Press and quickly release the SOURCE button on the projector cabinet to display the Source list. Each time the SOURCE button is pressed, the input source will change as follows: "RGB1", "RGB2" (computer or DVD with component output), "Video" (VCR, document camera, or laser disc player), "S-Video", "DVI (Digital)", "Viewer" (slides on a PC card), or "LAN" (wired or wireless signal aired from a PC).

To display the selected source, press the ENTER button.

Detecting the Signal Automatically

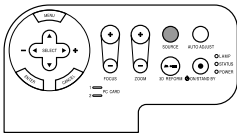

Press and hold the SOURCE button for a minimum of 1 second, the projector will search for the next available input source. Each time you press and hold the SOURCE button, the input source will change as follows:

→ RGB1 → RGB2 → Video → S-Video → DVI (Digital) → Viewer

If no input signal is present, the input will be skipped. When the input source you wish to project is displayed, release the button. Press the ENTER button.

Adjusting the Picture Size and Position

Place your projector on a flat level surface and ensure that the projector is square to the screen.

Lift the front edge of the projector to center the image vertically.

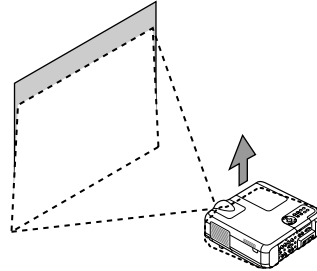

Move the projector left to center the image horizontally on the screen.

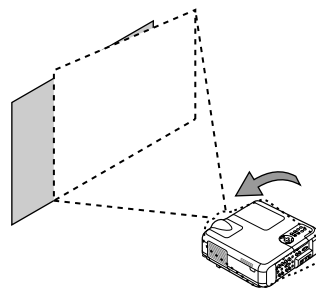

* If the projected image does not appear square to the screen then use the 3D Reform feature for proper adjustment. See page E-20.

Adjust the Tilt Foot

1. Lift the front edge of the projector.

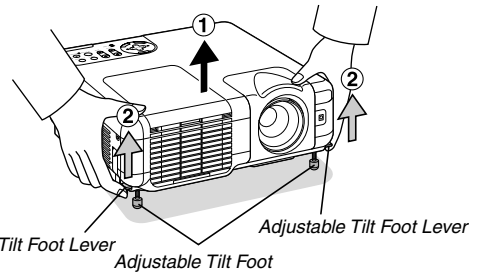

2. Push up the Adjustable Tilt Foot Levers on the right and left sides of the projector to extend the adjustable tilt feet (maximum height).
3. Push down the Adjustable Tilt Foot Levers.

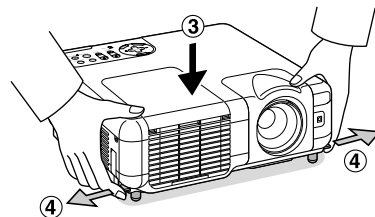

4. Lower the front of the projector to the desired height (max. 44.5mm/ 1.8") and release the Adjustable Tilt Foot Lever to lock the Adjustable tilt foot. There is approximately 10 degrees of up and down adjustment for the front of the projector.

WARNING: To avoid premature lamp failure, do not tilt the front of the projector up or down by more than 15° from level.

CAUTION:

Do not use the tilt-foot for purposes other than originally intended. Misuses such as gripping the tilt-foot or hanging on the wall can cause damage to the projector.

Zoom

Use the ZOOM Button (+/-) to fine adjust the image size on the screen

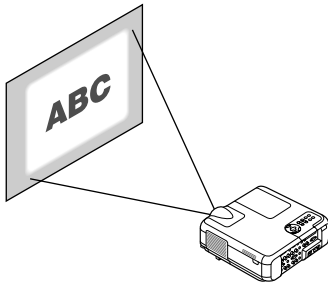

You can use ZOOM +/- button to enlarge or reduce an image size within a range of +/-15%.

Focus

Use the FOCUS Button (+/-) to obtain the best focus.

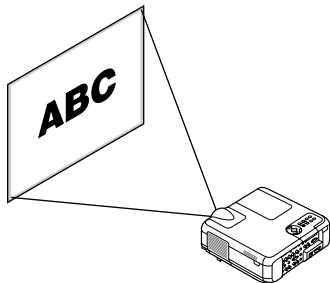

Using Auto Focus

Press and hold the AUTO ADJUST button on the cabinet or AUTO ADJ button on the remote control for a minimum of 2 seconds. The focus pattern will be displayed for a moment and then the best focus will be automatically obtained.

NOTE: The Auto Functions have two options: Focus and Wall Color Correction. When the AUTO ADJUST or AUTO ADJ button is pressed and held for a minimum of 2 seconds, either item can be executed. You can decide in advance which item will be enabled at the time of execution.

From the Advanced menu, select [Projector Options] → [Auto Functions]. You can turn on or off "Focus" and "Wall Color Correction". See page E-49.

NOTE: Just pressing quickly the AUTO ADJUST button on the cabinet or AUTO ADJ button on the remote control will enable the Auto Adjust feature instead of the Auto Focus feature.

NOTE:

Geometric Correction Tool

If you use a special shaped screen such as a cylindrical or spherical screen, a downloadable program, Geometric Correction Tool is available.

This program (Geometric Correction Tool) enables the geometrical distortion correction of an image when projected onto a special shaped screen with an Dukane projector. Additionally, this program allows control of the projector via a computer.

For additional information visit:

US : <http://www.dukcorp.com/av>

Correcting the Horizontal and Vertical Keystone Distortion (3D Reform)

Use the 3D Reform feature to correct keystone (trapezoidal) distortion to make the top or bottom and the left or right side of the screen longer or shorter so that the projected image is rectangular.

In the following description, 3D Reform (Cornerstone) correction can be done with the USB mouse or remote control, cabinet buttons.

When using the remote control or cabinet buttons:

1. Project an image so that the screen is smaller than the area of the raster.
2. Pick up any one of the corners and align the corner of the screen with the one of the image.

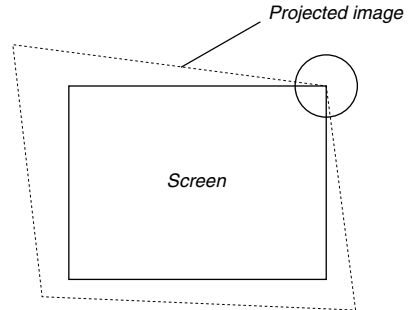

(The drawing shows the upper right corner.)

3. Press the 3D REFORM button on the remote control.



The CORNERSTONE adjustment screen is displayed.

NOTE: Press the 3D REFORM button to toggle between "Cornerstone" and "Keystone."

4. Use the SELECT ▲▼◀▶ button to select one icon which points in the direction you wish to move the projected image frame.

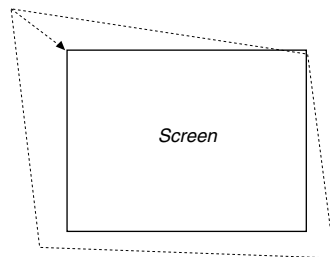

5. Press the ENTER button.
6. Use the SELECT ▲▼◀▶ button to move the projected image frame as shown on the example.

7. Press the ENTER button.

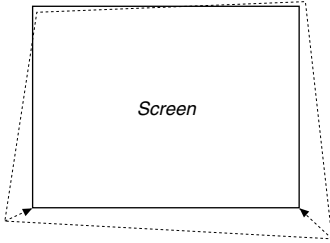

8. Use the SELECT ▲▼◀▶ button to select another icon which points in the direction.

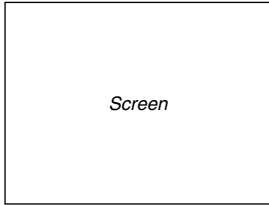

On the Cornerstone adjustment screen, select "Exit" and then "OK", or press the CANCEL button on the remote control.

The confirmation screen is displayed.



9. Press the SELECT ◀ or ▶ button to highlight the [OK] and press the ENTER button.

This completes the keystone correction. Selecting "Cancel" will return to the adjustment screen without saving changes (Step 3). Selecting "Reset" will return to the factory default. Selecting "Undo" will exit without saving changes.

When using the USB connected to the projector

Preparation: Connect the USB mouse to the projector. See page E-28.

1. Project an image so that the screen is smaller than the area of the raster.
2. Pick up any one of the corners and align the corner of the screen with the one of the image. (The drawing shows the upper right corner.)

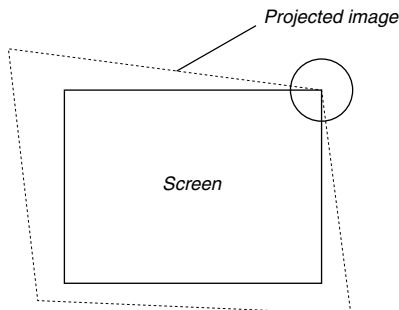

3. Press the 3D REFORM button on the remote control. The Cornerstone adjustment screen is displayed. The Cornerstone adjustment screen will disappear when you move the USB mouse cursor.

4. Point to one of the remaining 3 corners and left-click on it.

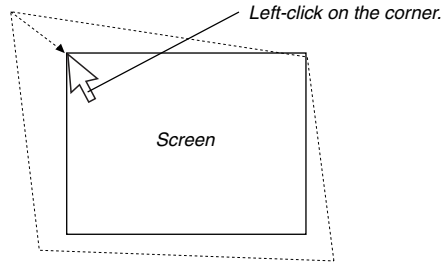

5. Do the above step 4 for the other two corners so that the projected area becomes smaller than the screen.

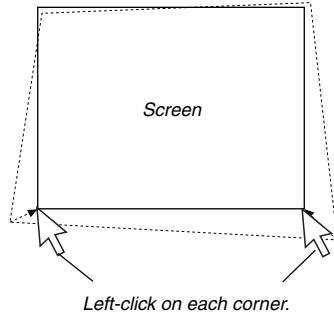

6. To complete the procedure, right-click anywhere on the screen. The confirmation screen is displayed.

7. Left-click on "OK". This completes the Cornerstone adjustment.
 - * To return the Cornerstone adjustment to the default settings, left-click on "Reset" in Step 7.

You can save your Cornerstone changes. The changes are saved when you turn off the projector. To do so, select [Projector Options] → [Setup] → [Page 4]. Select the 3D Reform Save check box. This is not selected at the time of shipment.

- * There are limitations of shapes which can be corrected using the Cornerstone adjustment. When adjusting the Cornerstone beyond these limits, you will get the message "Out of adjustment range!" and no correction can be done. Should this happen, do the Cornerstone adjustment again within the allowable range.
- * Due to limitations of accuracy within internal processes, there may be some discrepancy of positions between the mouse cursor and corrected shape or one corner and the other 3 corners.

NOTE: To return the 3D Reform correction setting values to the factory default, press and hold the 3D REFORM button for a minimum of 2 seconds.

NOTE: During 3D Reform adjustment, "Aspect Ratio" and "Screen" may not be available. Should this happen, first reset the 3D Reform data and then do each setting. Second repeat the 3D Reform adjustment. Changing Aspect Ratio and/or Screen setting can limit 3D Reform in its adjustable range.

The adjustable ranges for 3D Reform are as follows:

Horizontal Max $\pm 35^\circ$ approx.
 Vertical Max $+50^\circ/-25^\circ$ approx.

* The following are conditions at the above maximum angle when all of the following are met

- Image is projected in Wide (Zoom)
- Resolution is XGA
Higher resolution than XGA limits 3D Reform in its adjustable range.
- Menu items should be set as follows:
Aspect Ratio 4:3
Screen Type 4:3
- Horizontal and Vertical are adjusted separately.
A combination of both adjustments limits 3D Reform in its adjustable range.
- When "4:3 Fill" is selected in Aspect Ratio, "Cornerstone" and "Horizontal Keystone" are not available.

Optimizing RGB Picture Automatically

Adjusting the Image Using Auto Adjust

Optimizing RGB image automatically

Press the Auto Adjust button to optimize an RGB image automatically.

[Poor picture]

AUTO ADJ.

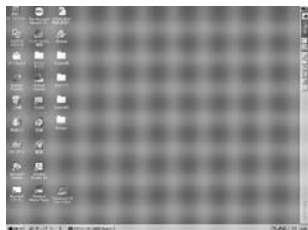

[Normal picture]

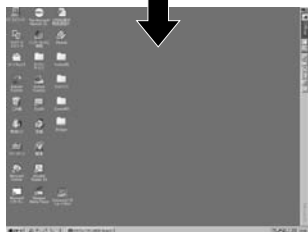

Press the Auto Adjust button to fine-tune the computer image or to remove any vertical banding that might appear and to reduce video noise, dot interference or cross talk (this is evident when part of your image appears to be shimmering). This function adjusts the clock frequencies that eliminate the horizontal banding in the image. This function also adjusts the clock phase to reduce video noise, dot interference or cross talk. (This is evident when part of your image appears to be shimmering.)

This adjustment may be necessary when you connect your computer for the first time.

NOTE:

- Some signals may not be displayed correctly or take time.
- The Auto Adjust function does not work for component and video signal.
- If the Auto Adjust operation cannot optimize the RGB signal, try to adjust Clock and Phase manually. See page E-41.
- Pressing and holding the AUTO ADJUST button on the cabinet or AUTO ADJ button on the remote control for a minimum of 2 seconds will enable the Auto Focus and the Auto Wall Color Correction feature instead of the Auto Adjust feature.

Turning Up or Down Volume

Sound level from the speaker and the AUDIO OUT jack (RCA) on the projector can be adjusted.

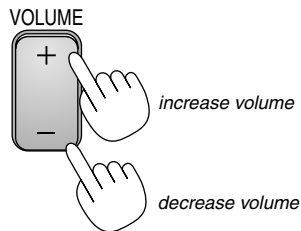

Volume bar

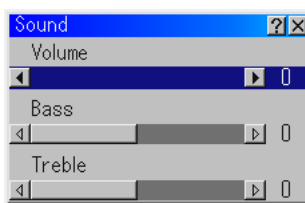

Using the Laser Pointer

You can use the laser to draw your audience's attention to a red dot that you can place on any object.

Press and hold the LASER button to activate the laser pointer.

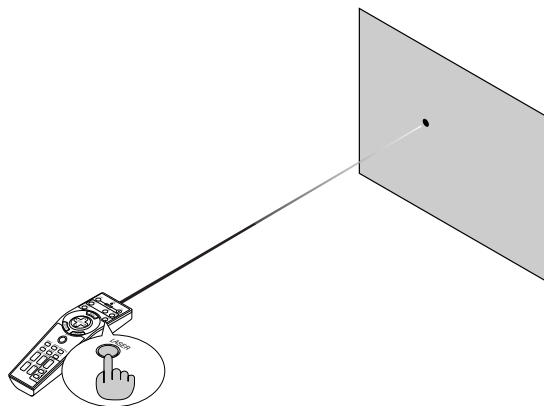

CAUTION:

- Do not look into the laser pointer while it is on.
- Do not point the laser beam at a person.

Setting the function switch

There are two switches on the bottom of the battery case: an applicable projector selector switch (1) and laser enable/disable switch (2). Check the projector being used and decide whether to enable or disable laser, then set these switches as necessary using the tip of a thin ball-point pen. On this model, an applicable projector selector switch (1) is not used.

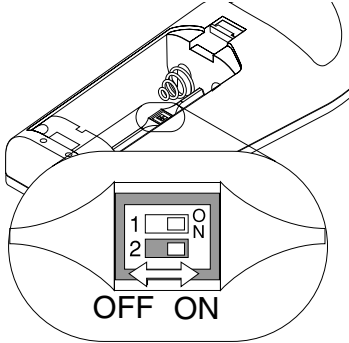

Switch (2)

- On: Enabled (the laser lights when the LASER button is pressed)
[Factory default]
- Off: Disabled (the laser does not light even when the LASER button is pressed)

Disable the laser when using in an environment in which the unit is accessible to children.

Turning off the Projector

To turn off the projector:

First press the POWER (ON/STAND BY) button on the projector cabinet or the POWER OFF button on the remote control for a minimum of two seconds. The power indicator will glow orange. After the projector turns off, the cooling fans keep operating for 90 seconds (Cooling-off time).

Second, turn off the Main Power switch. The power indicator will go out. Last unplug the power cable.



CAUTION

Do not unplug the power cable from the wall outlet or do not turn off the main power under any one of the following circumstances. Doing so can cause damage to the projector:

- While the Hour Glass icon appears.
- While the message "Please wait a moment." appears. This message will be displayed after the projector is turned off.
- While the cooling fans are running. (The cooling fans continue to work for 90 seconds after the projector is turned off).
- While accessing a PC card. (The PC Card Access indicator lights.)

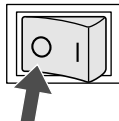

CONVENIENT FEATURES

Using the Remote Mouse Function

The built-in remote mouse function enables you to operate your computer's mouse functions from the remote control (Computer mode). It is a great convenience for clicking through your computer-generated presentations. To return to the projector operation mode (Projector mode), press the PJ button (lit red).

Connecting to your computer for the remote mouse function

If you wish to use the remote mouse function, use the supplied USB cable to connect the USB port (PC) of the projector and the USB port (type A) of your computer.

NOTE: Depending on the type of connection or OS installed on your computer, you may have to restart your computer or change your computer settings.

When using the USB Port

For PC, the mouse receiver function can only be used with a Windows 98, Windows ME, Windows XP or Windows 2000 operating system.

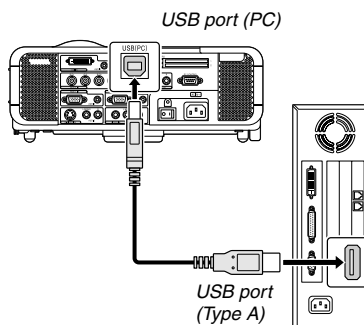

NOTE: Wait at least 5 seconds after disconnecting the USB cable before reconnecting it and vice versa. The computer may not identify the built-in mouse receiver if it is repeatedly connected and disconnected in rapid intervals.

Switching operation mode between computer and projector

The three shaded buttons shown on the drawing work as a computer mouse in the Computer mode. In the Computer mode the PJ button is not lit.

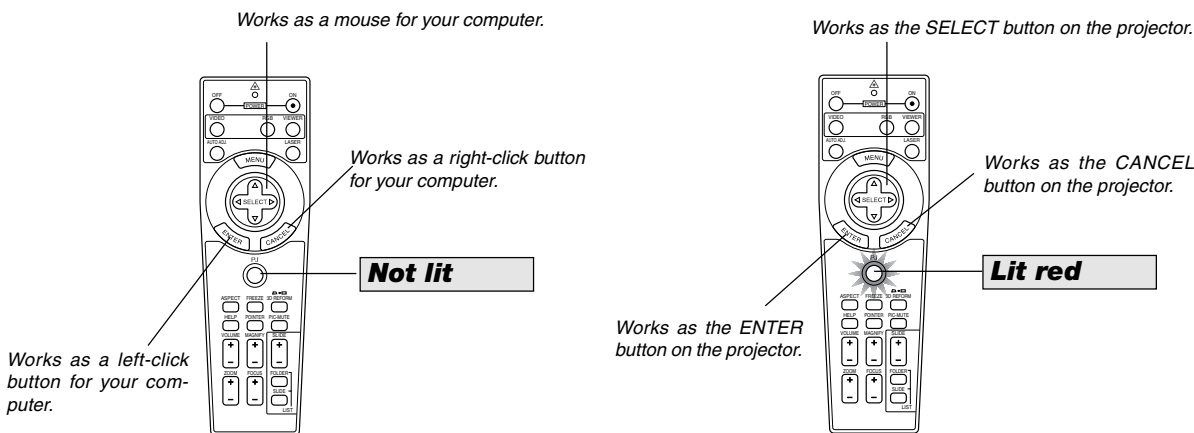

- When the MENU button is pressed, the PJ button lights red to indicate that you are in the Projector mode, which allows the projector menu operation using the three buttons.
- When the POINTER button is pressed, the PJ button lights red to indicate that you are in the Projector mode and that the SELECT $\blacktriangle\blacktriangleright$ button works as a moving button for the POINTER or magnified image.
- If no buttons are pressed within 60 seconds, the PJ button's light goes out to indicate that you are in the Computer mode. To enable the projector menu operation again, press the PJ button to light red. To move the pointer or a magnified image again, turn off the pointer and then turn on the pointer (press the POINTER button two times).
- When the PJ button is lit, if you want to use the mouse function immediately, press the PJ button to return to the Computer mode (not lit).

During Computer mode:

In Computer mode, by pressing the ENTER button for 2 seconds or more then releasing, the drag mode is set and the drag operation can be performed simply by pressing the SELECT $\blacktriangle\blacktriangleright$ (mouse) button. To drop the item, press the ENTER (left click) button again or press the CANCEL (right click) button.

Auto 3D Reform

Auto 3D Reform automatically corrects distortion by sensing the outline or outer frame of your screen with the projector's built-in image sensor to project an image within the screen.

NOTE:

- The Auto 3D Reform feature supports screen sizes between 30" and 200".
- If the screen has the same brightness as its background, the built-in image sensor on the front of the projector can fail to recognize the outline or outer frame of the screen.
Should this happen, the Auto 3D Reform feature cannot function.
If irregular colors, flaw or change of color are seen on the screen, the built-in sensor can mistakenly interpret the outline or outer frame of the screen.
- If there is an object between the built-in sensor and the screen, the screen cannot be recognized.
- The Auto 3D Reform feature does not support reflective screens. Matt type or beads type screens are recommended.

Executing the Auto 3D Reform feature

1. Project an image.
See the user's manual or the quick connect guide for projecting an image.
2. Press the 3D REFORM button.
The 3D Reform (Cornerstone) screen is displayed.

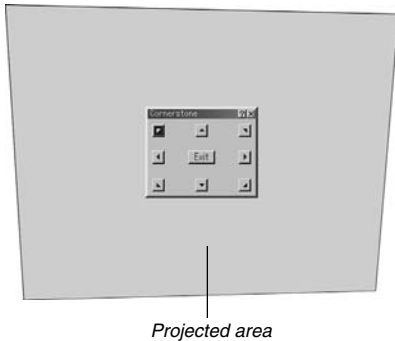

3. Press and hold the AUTO ADJUST button for a minimum of 2 seconds.
A guide pattern that shows available area for Auto 3D Reform is displayed.
- * The AUTO ADJ. button on the remote control can also be used for this purpose.

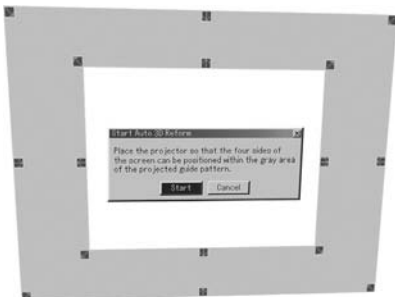

4. Place the projector adjusting its orientation and the angle so that the outline (outer frame) of the screen can be positioned within the gray area of the projected guide pattern.

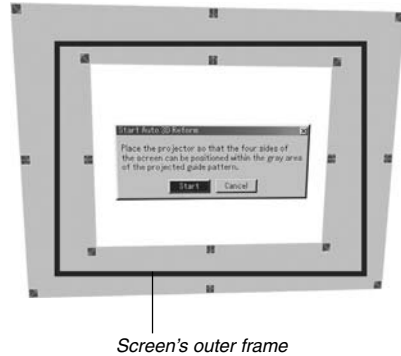

5. Highlight [Start] and press the ENTER button.
The Auto 3D Reform feature has been executed. Processing takes about 20 seconds
- * To cancel, use the SELECT ◀ or ▶ button to highlight [Cancel] and press the ENTER button.



NOTE:

- * When "4:3 Fill" is selected in "Aspect", the Auto 3D Reform feature is not available.
- * If the screen's outer frame is larger than gray area of the guide pattern as shown, the Auto 3D Reform feature does not function.
- * In the Auto 3D Reform mode, when controlling the projector using PC control, you might not be able to make correction. (The projector can be operated with Dynamic Image Utility 2.0, Image Express Utility 1.0 and HTTP Server function.)

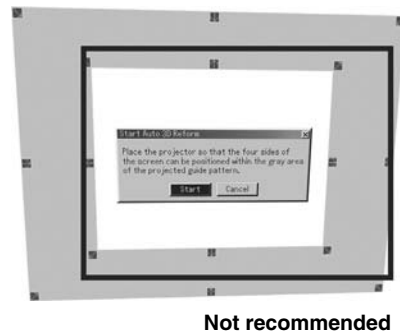

Setting Screen of Auto 3D Reform

1. Press the MENU button.
The Basic menu is displayed.
* When the Advanced menu is displayed, go to Step 3.
2. Use the SELECT ▲ or ▼ button to highlight "To Advanced Menu" and press the ENTER button.
The Advanced menu is displayed.
3. Use the SELECT ▲ or ▼ button to highlight "Projector Options".
Press the SELECT ► button. The "3D Reform" option is highlighted.
4. Use the SELECT ▲ or ▼ button to highlight "Auto Functions".
Press the SELECT ► button. The "Auto Functions" screen is displayed.

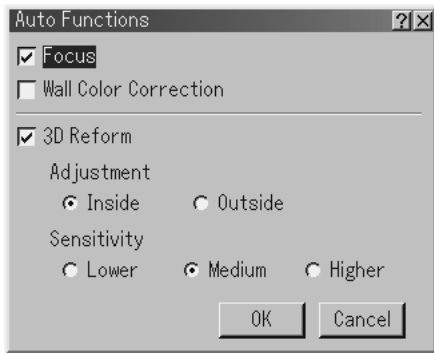

Focus See page E-49.

Wall Color
Correction See page E-49.

3D Reform Clear a check mark from the check box to disable
the Auto 3D Reform.

Adjustment

Inside Corrects so that an image is projected inside of
the screen outline.

Outside Corrects so that an image is projected outside of
the screen outline.

Sensitivity If the built-in sensor sensitivity is so strong that it
recognizes even lines within the screen, select
"Lower". If the built-in sensor sensitivity is too weak
to recognize the screen, select "Higher".

NOTE: If you failed to correct for placing the image inside of the screen using [Inside], the projector automatically corrects to project the image larger than the outer frame of the screen.

Turning Off the Image and Sound

Press the Picture Mute button to turn off the image and sound for a short period of time. Press again to restore the image and sound.

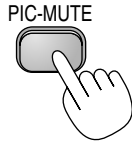

Freezing a Picture

Press the Freeze button to freeze a picture. Press again to resume motion.



Using the Pointer

You can use one of nine pointers to draw your audience's attention to the portion of a projected image you want.

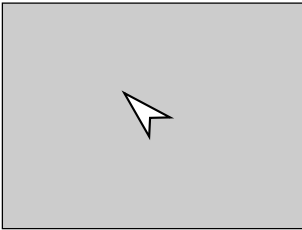

Press the Pointer button to display the pointer.

Press the Pointer button to display the pointer.

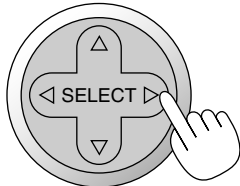
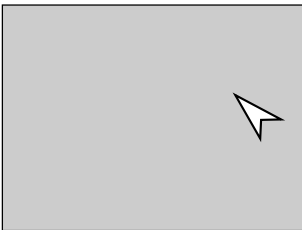

Use the Select button to move the pointer.

Use the Select button to move the pointer.

Enlarging and Moving a Picture

You can enlarge the area you want up to 400 percent. To do so:

1. Press the Pointer button to display the pointer.

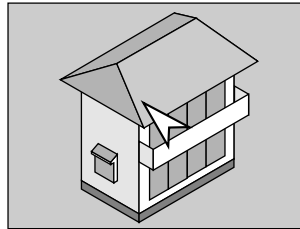

2. Move the pointer to the area you want to enlarge.

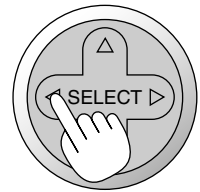
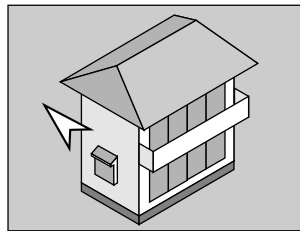

3. Enlarge the selected area.

When the Magnify (+) button is pressed, the image is magnified. To move the magnified image, use the SELECT button.

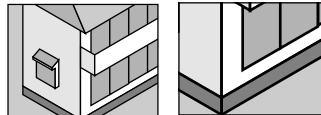

4. Return the image to the original size.

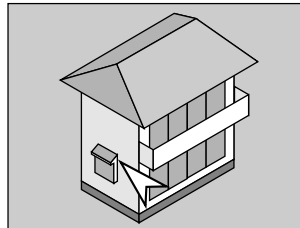

Getting the On-line Help

You get the contents about Help.



Display Help

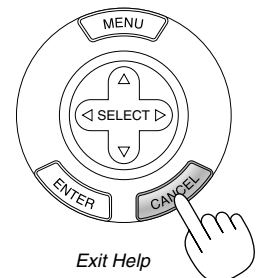

Exit Help

Using a USB Mouse

Using a USB mouse gives you a smooth operation. A commercially available USB mouse is required.

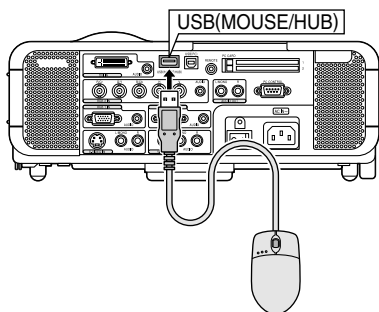

NOTE:

- The MT1065 comes with a USB mouse.
- There may be some brands of USB mouse that the projector does not support.

Operate the Menus using the USB mouse

Mouse Cursor

When connecting a USB mouse to the projector, you get a mouse cursor on the screen.

Unless you use your USB mouse within 10 seconds, the mouse cursor disappears.

Menu Display

Clicking with a mouse button displays the menu.

Clicking ► displays the pull-down menu. To close the menu, click anywhere in the background.

Adjusting and Setting Display

You can select a menu item and click with a mouse button to make adjustments and setting.

Examples

Click (or press and hold) the mouse button ◀ or ▶ to adjust the brightness. Or click and drag the mouse button on the slide bar horizontally to adjust it.

To save the adjustments, click . The display is closed. If you click anywhere in the background while displaying adjustment and setting menu or dialog box, you will get the main menu at the clicking point.

Using the middle button on the mouse

The projector supports the middle button on your mouse. With the middle button you can use a scroll bar when it is available or click the middle button to display or hide the Chalkboard toolbar.

Using the USB HUB Function

When using the projector with a PC via the supplied USB cable, both the USB port(type A) on the projector can be connected to a USB-supported scanner or other USB-supported device. (USB Hub Function)

Example: When connecting a PC and a scanner to each USB port respectively

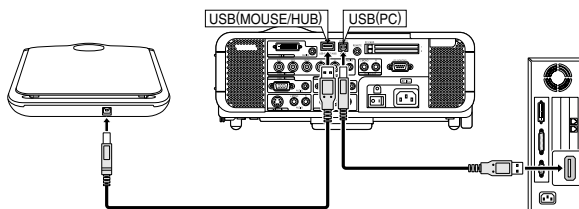

An example of how a scanned image is projected

1. Install the Dynamic Image Utility on your PC.

NOTE: The Dynamic Image Utility is contained on the supplied CD-ROM. See the supplied NEC Software Utility Installation Guide for the installation procedure.

2. Use your scanner to scan an image.

NOTE: A scanner driver must be installed on your PC before use.

3. Load the scanned image on your PC using the Dynamic Image Utility.
4. Transmit the scanned image from your PC to the projector via the USB cable and project the image on the screen.

NOTE:

- The USB HUB function is effective only when "Auto" is selected in Operation Mode Select.
- The PCs using the USB Host Controller may not be available.
- When connecting a USB hub to the USB port (type B) on the projector, be sure to use a USB hub capable of supplying 500mA per port of downstream current.

Changing Background Logo

You can change the default background logo using the PC Card Files feature.

NOTE: File size must be 256KB or less. Other file formats than JPEG and BMP are not available.

1. From the menu, select [Tools] → [PC Card Files] to display a list of all the files stored in the PC card so that you can select a file you want to use as a background logo.

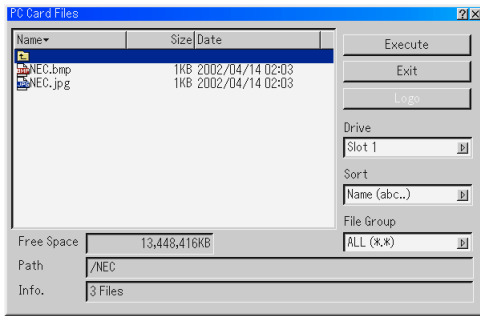

2. The Logo button allows you to select a background logo from graphic files on a PC card and change to it as the background logo.
3. Use the SELECT ▲ or ▼ button to select a JPEG or BMP file for your background logo.
4. Use the SELECT ► and then ▼ button to select "Logo".
5. Press the ENTER on the remote control or the cabinet. You will get the confirmation dialog box.
6. Select "OK" and press the ENTER button. This completes changing a logo for the background.

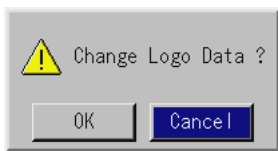

- * Once you have changed the background from the logo to another, you cannot return the logo to background even by using Factory Default. To do so, repeat the above steps. The logo file is included on the supplied CD-ROM Projector User Supportware (Logo/nec_bb_x.jpg).

Making Freehand Drawings on a Projected Image (ChalkBoard)

The ChalkBoard feature allows you to write and draw messages on a projected image.

NOTE: The ChalkBoard feature is available only when a USB mouse is used.

From the menu, select [Tools] → [ChalkBoard] to display the ChalkBoard tool bar that contains the following icons.

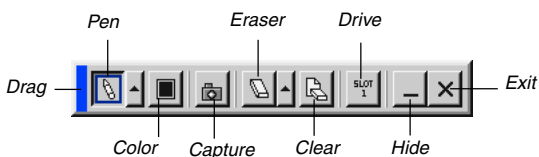

- Drag Drags to move the tool bar by clicking on the blue part. (for USB mouse operation only)
- Pen Left-click and drag to draw. Left-click [▲] or right-click the pen icon to display the pen palette containing four lines of different thickness from which you can select a line you prefer by left-clicking.
- Color Selects a color. Left-click to display the color palette from which you can select a color you prefer by left-clicking.
- Capture Left click to capture and save freehand drawings in the PC card.
- Eraser Left-click and drag to erase part of a drawing. Left-click [▲] or right-click the eraser icon to display the eraser palette containing four eraser of different thickness from which you can select an eraser you prefer by left-clicking.
- Clear Left-click to clear the drawing completely from the ChalkBoard screen.
- Drive Switches between PC Card slot 1 and 2.
- Hide Hides the tool bar by left-clicking. Right-clicking anywhere on the screen displays the ChalkBoard tool bar again.
- Exit Clears the complete drawing and exits the ChalkBoard.

NOTE:

- The menu is not available while you display the ChalkBoard screen.
- Switching slides clears a drawing completely.

USB Memory Device or USB Memory Card Reader Support

The projector is compatible with either a USB memory device or USB memory card reader which supports the viewer and security features.

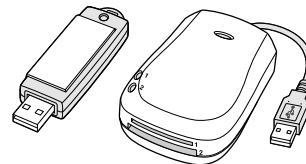

- To use a USB memory device or USB memory card reader, connect the device to the USB port (type A).
- Select one of the Drive icons in the Viewer toolbar, Capture toolbar and PC Card File setting screen. Up to four drives can be accepted.
- To use a USB memory device as a Protect key for Security function, select one from the Drive icons in the Security setting screen.

NOTE:

- Some USB memory devices (brands) or USB memory card readers may not work.
- You cannot use a USB memory device and a USB memory card reader when connecting a USB mouse to the projector. Using a USB HUB that allows multiple USB memory devices or card readers is not supported either.
- Do not do the following while the USB memory device or USB memory card reader's access indicator is lit or flashing (while data is being accessed.) Doing so can damage your USB memory device or USB memory card in the reader. Back up your data in case it will need to be restored.
 - * Pulling out the USB memory device or USB memory card reader from the USB port of the projector.
 - * Pulling out the memory card from the USB memory card reader
 - * Turning off the main power switch or unplugging the power cable.
- The drive for "USB 1-4" is displayed only when the USB memory device or USB memory card reader is connected to the projector. The drive for "USB 1-4" may be displayed differently from the one in the USB memory card reader.
- Some USB memory devices (brands) or USB memory cards cannot be used as Protect key for the projector's Security function.

USING THE VIEWER

NOTE:

- To use the Viewer, first you need to create presentation materials on your PC using the Dynamic Image Utility 2.0 contained on the supplied Projector User Supportware CD-ROM. For installation, see the printed Software Utility Installation Guide. For creating presentation materials, see the Slide show function on the on-line manual of the Dynamic Image Utility 2.0.
- Selecting Viewer sets the audio input for DVI input.

Making the Most out of the Viewer Function

Features

You can view presentation data, capture, and play images on the projector. A PC card is used to view presentation data prepared on the computer and to capture and play images projected with the projector. The Viewer feature allows you to view slides stored on a PC memory card (referred to as PC card in this manual) on the projector. Even if no computer is available, presentations can be conducted simply with the projector. This feature is convenient for holding presentations at meetings and in offices, as well as for playing images taken on digital cameras.

Easy to use

- Presentations can be started immediately simply by inserting a PC card (not supplied)
- Easy slide switching
- Remote control operation
- Jumping to list of slides or any specific slide

High quality images

- High resolution up to 1024 x 768 dots
- 24-bit full color playback
- Viewing of digital camera images

Simple utility software (for computer)

- Dynamic Image Utility 2.0 operable on Windows 98/Me/XP/2000
- Slides can be created by capturing the currently displayed image
- Control screen for displaying lists of slides and editing
- * Microsoft, Windows and PowerPoint are registered trademarks of Microsoft Corporation.

Inserting and Removing a PC Card

NOTE:

- Do not try to force the PC card into the slot.
- A dummy card is inserted into each slot at the time of shipment. First remove the dummy cards before use.

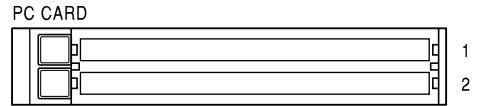

Inserting the PC Card

- Hold the PC card horizontally and insert it slowly into PC card slot 1 or 2 with its top facing up.
- The eject button pops out once the PC card is fully inserted. Check that the PC card is fully inserted.

PC card (not supplied)

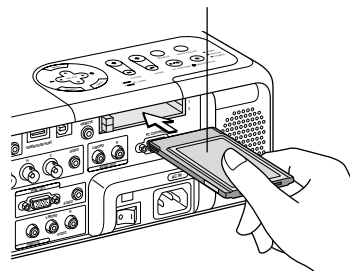

Removing the PC Card

Press the eject button. The PC card pops out a little. Grasp the edges of the PC card and pull it out.

NOTE: Do not eject the PC card while its data is being accessed.

Eject button

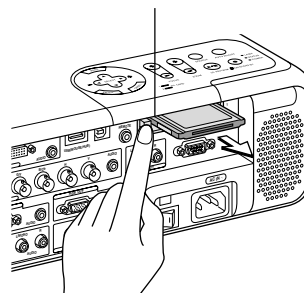

Direction for Inserting the PC Card

The PC card has a top and bottom and must be inserted into the PC card slot in a specific direction. It cannot be inserted backwards or upside-down. Attempting to force it into the slot in the wrong direction may break the internal pin and damage the card slot. Refer to the PC card's operating instructions for the proper direction of insertion.

PC Card Type

The PC Card slot accepts PCMCIA Type II only.

NOTE: The projector does not support FAT32 or NTFS formatted flash memory card or USB memory device. Be sure to use a flash memory card or USB memory device formatted with the FAT16 or FAT file system.

To format your flash memory card or USB memory device in your computer, refer to the document or help file that comes with your Windows.

Operating the Viewer Function from the Projector (playback)

This section describes the operation for showing slides of presentation documents created using the Viewer function with the projector. It is also possible to make slides directly from the images projected with the projector.

Projecting slides (Viewer)

1. Insert a PC card into the PC card slot.
Insert the PC card so that the end with the insertion direction arrow on the top goes in first.
* Press the eject button to eject the card.
2. Select the "Viewer" from the Source Select menu.
3. Project slides.

Checking "Show Folder List", means that selecting Viewer input displays a list of the folders in the PC card and if "Auto Play" is checked the projector automatically starts to play slides at the first slide of the folder you have selected.

A tool bar will appear when you press the MENU button on the remote control or the projector cabinet or clicking with the right button of a mouse.

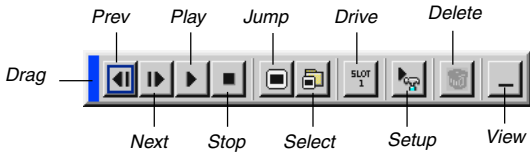

The tool bar includes the following buttons:

- Drag Drags to move the tool bar. This is available for USB mouse operation only.
- Prev Returns to the previous slide or folder. Or this lets you play slides back in reverse.
- Next Advances to the next slide or folder. Or this lets you play slides back.
- Play Plays back automatically or manually depending on the setting on Viewer Options of the menu. This allows you to move on to the next slide when "Manual Play" is selected.
- Stop This allows you to stop Auto Play while you are playing back and to resume playing from the selected slide or folder when "Auto Play" is selected.
- Jump Displays a list of slides while you are playing back.
- Select Displays a list of folders while you are playing back.
- Drive Switches between PC Card slot 1 and 2.
- Setup Displays the Viewer Options dialog box on Page 2 of the Setup dialog box.
- Delete Deletes a captured slide(s) or all the captured slides in the Capture - specific folder.
- View Hides the tool bar while you are playing back. Pressing the MENU button or clicking with the right button of a mouse shows it again.

NOTE: If no memory card is inserted in the PC CARD slot, there is no signal, and a black, blue or logo background is displayed, depending on the setting. Playback is stopped when SLIDE +/- button on the remote control or ◀ button on the cabinet is pressed in Auto Play mode.

Up to 12 indexes can be displayed on the list of folders. The folder in the right bottom is always a folder exclusively for captured images, but is only displayed when images have been captured.

When the tool bar is not displayed:

Press the FOLDER LIST button or the SLIDE LIST button on the remote control to display folders or from a PC card in the projector's PC Card slot.

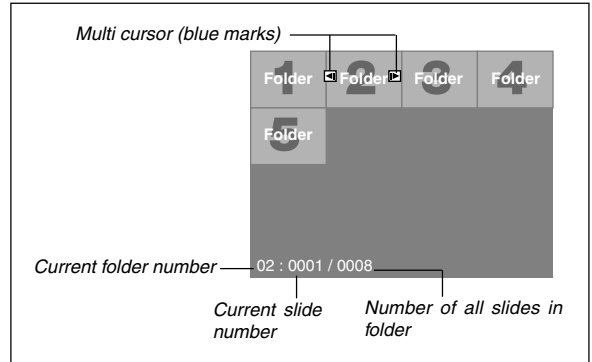

Use the SLIDE +/- button to advance to the next folder or return to the previous folder.



Use the SLIDE +/- button to advance to the next slide or return to the previous slide.

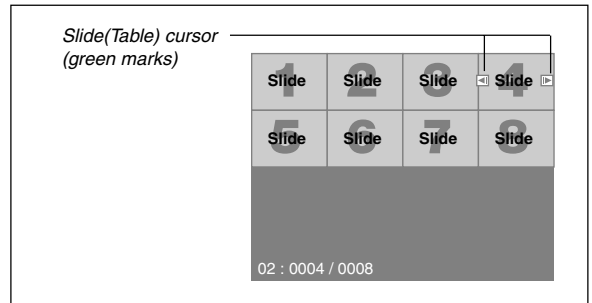

NOTE: You can also use the ◀ and ▶ button on the remote control to select folders or slides.

If you use the ◀ and ▶ button on the remote control for Viewer operation, press the PJ button to switch to the Projector mode and the PJ button lights red.

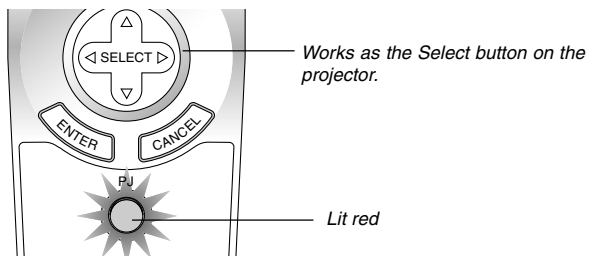

Auto Play Mode

If the "Auto Play" option is selected in "Viewer Options" of the menu, any given slide will start to play automatically.

You can also specify Auto Play Interval between 5 and 300 seconds.

Switching to Slides Directly from Other Input Modes

With this function it is possible to switch directly to a slide when the picture of a VCR or computer is being projected.

Example: When conducting presentations using a combination of slides and moving pictures from a VCR, etc., it is possible to switch from a Viewer slide to the video picture then back to the Viewer slide simply by using the Viewer button.

NOTE: Even if you switch the current Viewer source to another source, the current slide is retained. When you return back to the Viewer, you will get the slide that has been retained.

The PC card editing operation cannot be performed from the projector. Do so using the Dynamic Image Utility 2.0 software.

Viewing Digital Images

Digital images can be played with the Viewer if the following conditions are met:

- If the image can be stored on an MS-DOS format PC card
- If the image can be stored in a format supported by the Viewer. With the Viewer, images on the card are searched for in directories and images in JPEG or BMP format are recognized as slides. Searchable directories are directories within two steps from the root directory, and searchable images are images within the first 12 files in the directory. Only file and slide switching are possible.

NOTE: The maximum number of images recognized as slides within one directory is 128.

Storing Images Displayed on the Projector on the PC card (Capture)

The Capture features allows you to capture an image from a source that is currently being displayed. The image is saved as JPEG in the PC card. When you select Capture from the menu, you will get a tool bar. You can capture an image directly using the tool bar when the menu is not displayed.

NOTE:

* Unless a PC card is inserted into the PC Card slot of the projector, the Capture feature is not available.

* The "Card Error" display means that the free space of the PC card is insufficient for saving images. Make more space available on the card by erasing unwanted images with your PC. The number of images that can be captured depends on the size of the PC card.

* Be sure not to turn off the power or remove the PC card while capturing an image. Doing so could cause a loss of the data in the PC card or damage to the card itself.

Preparations:

Insert the PC card into the card slot.

Insert the PC card so that the end with the insertion direction arrow on the top goes in first.

* Press the eject button to eject the card.

1. Project the image you wish to store on the projector.
2. Select the "Capture" from the Tools menu.

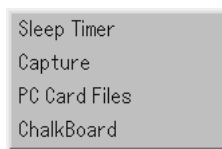

3. A tool bar will appear.

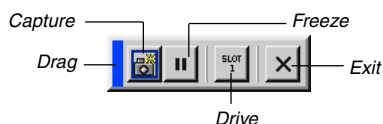

The tool bar includes the following buttons:

- Drag Drags to move the tool bar by clicking on the blue part (for USB mouse operation only).
- Capture Captures an image and save it as a JPEG file on a PC card.
- Freeze Freezes and unfreezes images.
- Drive Switches between PC Card slot 1 and 2.
- Exit Exits the Capture function. Another option to exit the Capture function is to press MENU or CANCEL button on the remote control or projector cabinet.

NOTE:

You can compress a captured file (JPEG) using the Capture Options in the Setup dialog. See page E-46.

Captured images with higher resolution than the projector's native resolution cannot be displayed correctly.

- File size of the captured image varies depending on the resolution of an input signal.
- An hourglass indicating that an image is being captured appears on the projector's display. Do not eject the PC card or turn off the projector's power while this icon is displayed. Doing so will damage the PC card data. If the PC card data is damaged, use a computer to repair the data.
- Up to 12 indexes can be displayed on the list of folders. The folder in the right bottom is always a folder exclusively for captured images, but is only displayed when images have been captured.

Deleting Captured Images

Using the Delete button on the tool bar for Viewer can delete captured images.

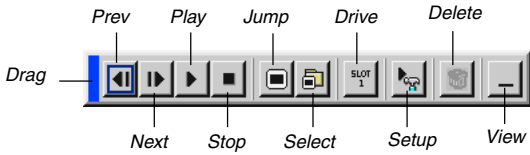

To delete captured images:

1. Select Viewer and display a folder list of captured images.
2. Use **▶** button to select the Capture folder [Cap] in the right bottom of the screen.
3. Press the MENU button to display the tool bar.
4. Use the **◀** or **▶** button to select the Delete icon and press the ENTER button or click with a mouse button.

Using the PC Card Files Function (PC Card Files)

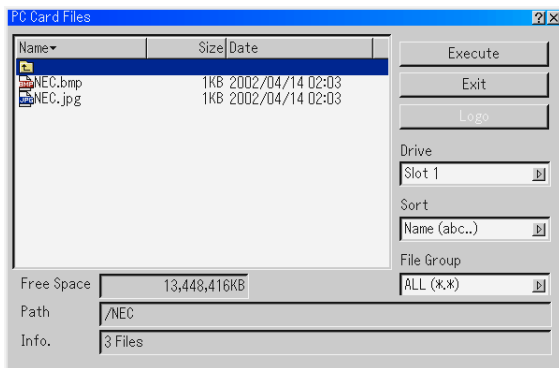

The PC Card Files function allows you to display a list of all the files stored in the PC card so that you can select a file you want to display. You can also sort files by file name or date, or display the file. Although a list of all the files in the PC card is displayed, you can view files in idx, text, HTML, JPEG and BMP format only. Selecting BMP and JPEG files automatically switches to the Viewer source. See also page E-39.

NOTE: This option is not available for selection unless a PC card is inserted properly.

Selecting "Execute" displays the file you selected. When you select a JPEG or BMP file and press the ENTER button on the remote or the cabinet, or "Execute" on the above, you will get a toolbar. This toolbar is used to return to the PC Card Files screen.

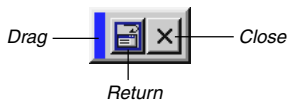

- Drag Drags to move the tool bar. (for USB mouse operation only)
- Return Returns to the PC Card Files screen.
- Close Close the toolbar.

USING ON-SCREEN MENU

Basic Menu Operation

Using the Menus

NOTE: The on-screen menu may not be displayed correctly while interlaced motion video image is projected.

1. Press the **MENU** button on the remote control or projector cabinet to display the Basic, Advanced or Custom Menu.

NOTE: When using a USB mouse, click the mouse button to display the menu. For other operations, do the same way as you use your PC mouse.

2. Press the **SELECT ▲▼** buttons on the remote control or the projector cabinet to highlight the menu for the item you want to adjust or set.
3. Press the **SELECT ►** button or the **ENTER** button on the remote control or the projector cabinet to select a submenu or item.
4. Adjust the level or turn the selected item on or off by using **SELECT ◀▶** buttons on the remote control or the projector cabinet.

The on-screen slide bar will show you the amount of increase or decrease.

5. Changes are stored until you adjust it again.

ENTER Stores the setting or adjustments.

CANCEL Return to the previous screen without storing settings or adjustments.

NOTE: You can close the main and sub menus simultaneously by pressing the **PJ** button on the remote control to cancel the Projector mode.

6. Repeat steps 2-5 to adjust an additional item, or press the **CANCEL** button on the projector cabinet or the remote control to quit the menu display.

Customizing the Menu

The Custom menu can be customized to meet your requirements. Selecting a menu item from the "Custom Menu Edit" list, allows you to custom tailor the menu items to your needs.

1. Select "Custom Menu Edit" to display the "Custom Menu Edit" screen.
2. Use the **SELECT ▲** or **▼** buttons to highlight your selection and press the **ENTER** button to place a check mark next to an option.

This action enables that feature. Press the **ENTER** button again to clear the check box.

If you select an item with a solid triangle **►** and press the **ENTER** button on the remote control or the projector cabinet, you can enable all the items within that submenu. Also you can turn on an item within the submenu without placing a check mark on the main menu item.

NOTE: Up to 12 main menu items (within Custom Menu Edit, not including submenu items) can be selected.

3. In order for the changes to take effect, use the **SELECT ◀▶** button on the remote control or the projector cabinet to highlight "OK", then press the **ENTER** button. To cancel the changes, use the **SELECT ▲** or **▼** buttons to highlight "Cancel" and press the **ENTER** button.

To return to the factory default, select "Reset" then press the **ENTER** button.

The default Custom Menu items are:

Source Select (RGB 1/2, Video, S-Video, DVI(DIGITAL), Viewer and LAN), Picture, Sound, Image Options (Aspect Ratio), Picture Management, Projector Options (3D Reform, Menu, Setup, Lamp Setting, Screen and LAN Mode), Tools (Sleep Timer, Capture, PC Card Files and ChalkBoard) and Help (Contents and Information).

NOTE: Once you have selected **OK** on the Custom Menu Edit screen, you cannot cancel the changes on the Menu screen. However, you can reedit the menu items over again as described in the steps above.

NOTE: If the "Advanced Menu" item has been selected on the Menu mode, you get the "Confirmation Change Menu" upon completion of "Custom Menu" editing. In this case, selecting "Yes" then "ENTER" will close all the menus and apply the changes from the Advanced menu to the Custom Menu. If you select "No" then "ENTER" functions, then all menu items will return to the Advanced menu, but your changes will still be available within the "Custom Menu" selection. To display the previously tailored Custom Menu, select "Custom Menu" from the "Menu Mode".

An item "To Advanced Menu" will be added to the bottom of the Custom Menu.

Selecting this item and pressing the **ENTER** button will display the "Advanced Menu" features.

Menu tree

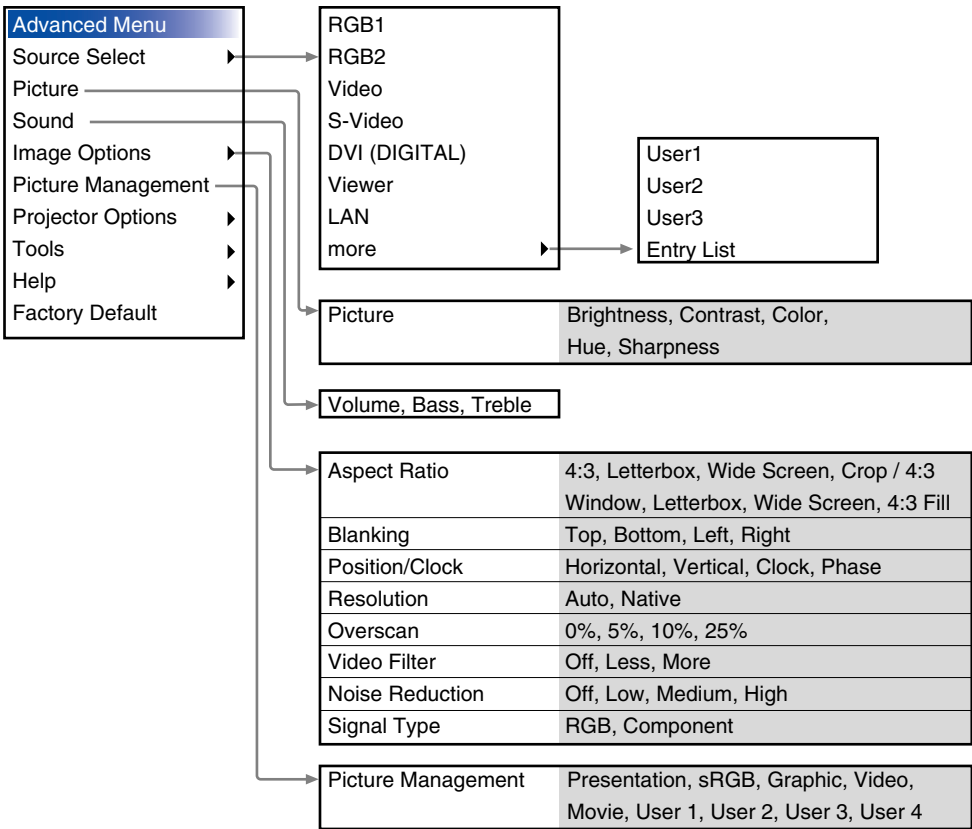

Advanced Menu
Source Select ▶
Picture
Sound
Image Options ▶
Picture Management
Projector Options ▶
Tools ▶
Help ▶
Factory Default

3D Reform ▶
Wall Color Correction
Menu
Setup
Lamp Setting
Screen
Auto Functions
LAN Mode
Password ▶
Security

Cornerstone
Keystone Horizontal, Vertical

Off, User 1, User 2, User 3, User 4 (Auto Adjust Button)

Menu	
Page 1	
Language	English, Deutsch, Français, Italiano, Español, Svenska 日本語
Menu Mode	Basic Menu, Custom Menu, Advanced Menu Custom Menu Edit
Projector Pointer	Pointer 1-9
Mouse Pointer	Pointer 1-9
Menu Display Time	Manual, Auto 5sec, Auto 15sec, Auto 45sec
Page 2	
Source Display	On, Off
Message	On, Off
Menu Color Select	Color, Monochrome

Setup	
Page 1	
Orientation	Desktop Front, Ceiling Rear, Desktop Rear, Ceiling Front
Background	Blue, Black, Logo
RGBOUT Terminal	Last, RGB1, RGB2
Closed Caption	Off, Caption1-4, Text1-4
Page 2	
Viewer Options	Show Folder List Auto Play, Manual Play, Interval
Capture Options	High Quality, Normal, High Compression
Mouse	Button Right Hand, Left Hand
	Sensitivity Fast, Medium, Slow
Operation Mode Select	Auto, Projector
Page 3 Signal Select	
RGB1	RGB/Component, RGB, Component, Scart
RGB2	RGB/Component, RGB, Component, Scart
Video,	Auto, PAL-M/PAL-N/NTSC3.58, NTSC3.58,
S-Video	NTSC4.43, PAL, PAL-M, PAL-N, PAL60, SECAM
Page 4	
Auto Adjust, Auto Start, Power Management, Power Off Confirmation, 3D Reform Save, High Speed Fan Mode, Built-in Speaker, Idle Mode, Clear Filter Usage Meter	
Page 5	
Remote Sensor	Front, Back, Left, Right
S-Video Mode Select	Off, S2
Page 6	
Communication Speed	4800, 9600, 19200, 38400
Default Source Select	Last, Auto, Select (RGB1, RGB2, Video, S-Video, DVI(DIGITAL), Viewer, LAN)
Control Panel	Enable, Disable
Key Lock	

Advanced Menu
Source Select ▶
Picture
Volume
Image Options ▶
Picture Management
Projector Options ▶
Tools ▶
Help ▶
Factory Default

3D Reform ▶
Wall Color Correction
Menu
Setup
Lamp Setting
Screen
Auto Functions
LAN Mode
Password
Security

Sleep Timer
Capture
PC Card Files
ChalkBoard

Contents
Information

Factory Default
All Data,
Current Signal

Lamp Mode	Normal, Eco
Lamp Type	Standard Lamp, Extended Life Lamp

Screen Type 4:3, 16:9 / Position

Focus	On, Off
Wall Color Correction	On, Off
3D Reform	On, Off
Adjustment	Inside, Outside
Sensitivity	Lower, Medium, Higher

LAN Mode	
IP Address	
Automatic	
Manual	IP Address, Subnet Mask, Gateway
Projector Name	
DNS Configuration	
Domain Name	
Network Type	
Mode	Infrastructure, 802.11 Ad Hoc, Ad Hoc Easy Connection
SSID	
Channel	1-14
TX rate	Automatic, 11M, 5.5M, 2M, 1M, 1M-2M-Automatic
WEP	
WEP	Disable, 64bit, 128bit
Key Select	Key1-4
Key1-4	
Mail	
Alert Mail	
Sender's Address	
SMTP Server Name	
Recipient's Address 1	
Recipient's Address 2	
Recipient's Address 3	
Test Mail	
Status	
IP Address	
Subnet Mask	
MAC Address	

Menu
Logo

Security	Enable, Disable, Keyword, Use Protect key, Drive, Read, Register, Delete
----------	--

Menu Elements

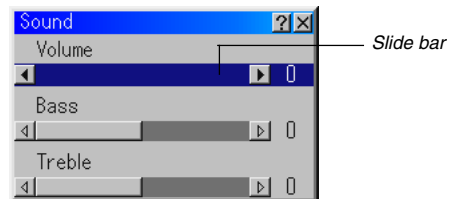
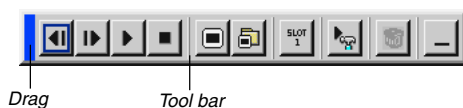
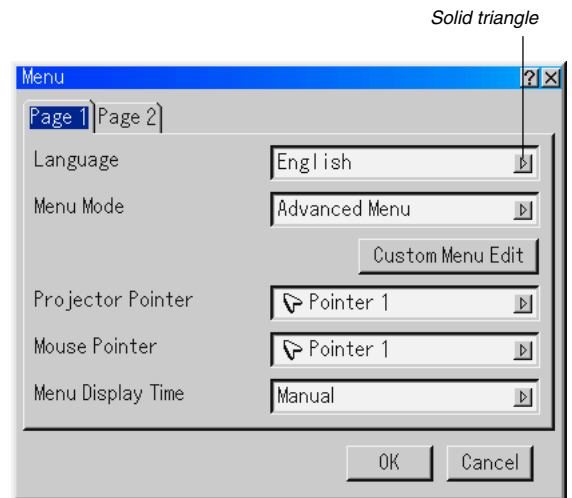
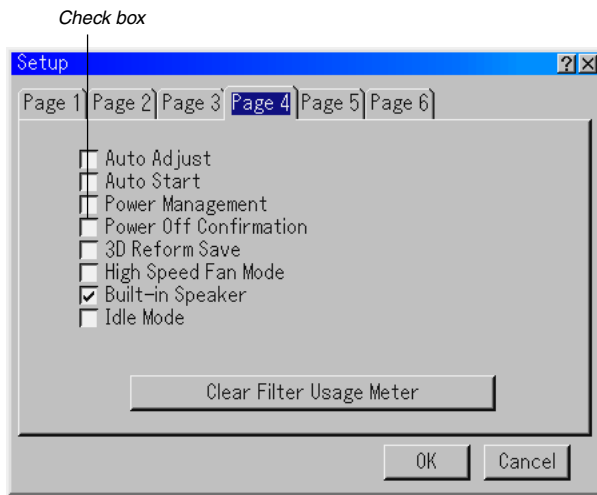
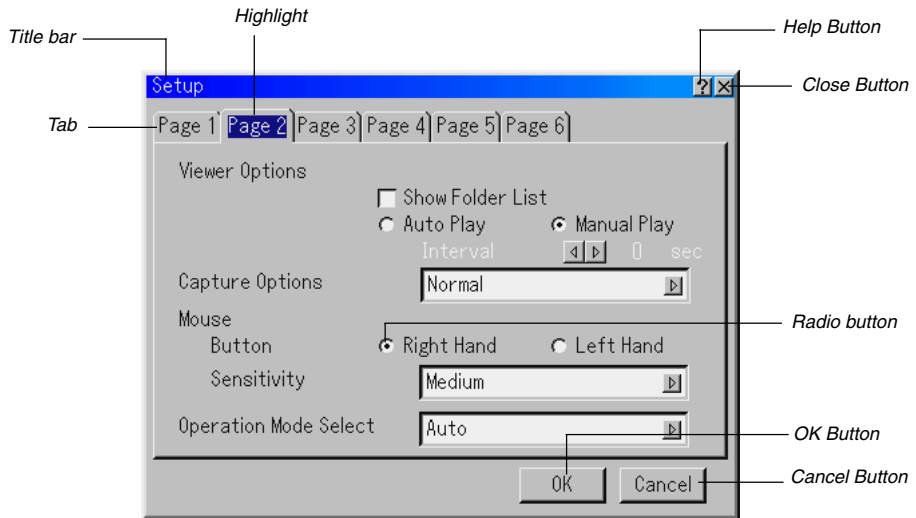

Menu windows or dialog boxes typically have the following elements:

- Title bar Indicates the menu title.
- Highlight Indicates the selected menu or item.
- Solid triangle Indicates further choices are available. A highlighted triangle indicates the item is active.
- Tab Indicates a group of features in a dialog box. Selecting on any tab brings its page to the front.
- Radio button Use this round button to select an option in a dialog box.
- Check box Place a checkmark in the square box to turn the option On.
- Slide bar Indicates settings or the direction of adjustment.
- OK button Press to confirm your setting. You will return to the previous menu.

- Cancel button Press to cancel your setting. You will return to the previous menu.
- Close button Click to close the window with saving changes. (USB mouse only)
- Help button Indicates that help about that feature is available (USB mouse only). Press the Help button on the remote control to display help.
- Toolbar Contains several icons for specific tasks. It is also referred to as "launcher".
- Drag Point the mouse here, and click and drag to move a toolbar.

Entering Alphanumeric Characters by Using the Menu

Alphabet or numeric characters are used for your IP address or projector name. To enter IP Address or projector name, use the software keyboard.

For using the software keyboard, see page E-64.

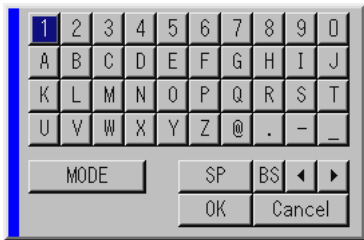

Menu Descriptions & Functions

Source Select

Selecting a Source

Enables you to select a video source such as a VCR, DVD player, laser disc player, computer or document camera depending on what is connected to your inputs. Press the SELECT ▲▼ button on the projector cabinet or on your remote control to highlight the menu for the source you want to project.

RGB

Selects the computer connected to your RGB1, RGB2 or component signal.

NOTE: An optional component cable (Component V or ADP-CV1 cable) is needed for a component signal.

Video

Selects what is connected to your Video input-VCR, laser disc player, DVD player or document camera.

S-Video

Selects what is connected to your S-Video input-VCR, DVD player, or laser disc player.

NOTE: A frame may freeze for a brief period of time when a video is played back in fast-forward or fast-rewind with a Video or S-Video source.

DVI (DIGITAL)

Selects the computer connected to the DVI input connector.

Viewer

This feature enables you to make presentations using a PC card that contains captured images and slides created with the exclusive Dynamic Image Utility 2.0 contained in the CD-ROM. See the supplied Software Utility Installation Guide for installing the Dynamic Image Utility 2.0. The starting screen for the Viewer varies depending on the settings of the Setup's Page 2. See Setup on page E-46.

NOTE: Even if you switch the current Viewer source to another source, the current slide is retained. When you return back to the Viewer, you will get the slide that has been retained. A launcher will appear when you press the MENU button.

A press of the MENU button displays the toolbar; a press of the MENU button again displays the Menu and hereafter each press of the MENU button switches displaying between the Menu and the toolbar. The launcher is a tool bar including the following buttons:

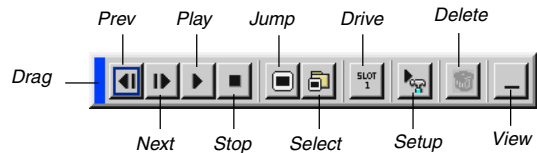

- Drag Drags to move the tool bar. (for USB mouse operation only)
- Prev Returns to the previous slide or folder.
- Next Advances to the next slide or folder.
- Play Plays back automatically or manually depending on the setting on Viewer Options of the menu. This allows you to move on to the next slide when "Manual Play" is selected.
- Stop Stops Auto Play while you are playing back and to resume playing from the selected slide or folder when "Auto Play" is selected.
- Jump Displays a list of slides while you are playing back.
- Select Displays a list of folders while you are playing back.
- Drive Switches between PC Card slot 1 and 2.
- Setup Displays the Viewer Options dialog box on Page 2 of the Setup dialog box.
- Delete Deletes a captured slide(s) or all the captured slides in the selected folder.
- View Hides the tool bar while you are playing back. Clicking with the right button of a mouse shows it again. Provides access to controls for your image. Use the SELECT button on the projector cabinet or the remote control to highlight the menu for the item you want to adjust.

LAN

Selects a signal from a LAN card plugged into the projector's card slot.

Entry List

No.	Name	Source	Input	Select	▲▼	✕
001	VGA	RGB	RGB1	✓		
002	SVGA	RGB	RGB2	✓		
003	NISCS3.58	Video	Video	User3	✓	
004	S-VIDEO	S-Video	S-Video	✓		
005	12345678901234567	RGB	RGB1	✓		
006	COMPO	Component	RGB1	✓		
007	Digital	---	DVI(DIGITAL)	✓		
008	Viewer	---	Viewer	✓		
009	Scart	Scart	RGB1	✓		
010						
011						

Displays the list of the entry signals. Use the SELECT ▲▼ buttons on your remote control or the projector cabinet to select the signal and press the ENTER button on the remote control or the projector cabinet to display the Entry Edit Command screen.

Using the Entry List

Making any adjustments to the current picture will automatically register its adjustments to the Entry List. The registered signal can be loaded any time from the Entry List.

NOTE: Up to 100 presets can be registered.

Entry Edit Command

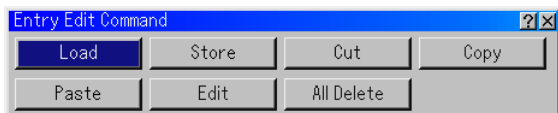

You can edit signals on the Entry List.

- Load Enables you to select a signal from the list.
- Store Enables you to store the currently projected signal.
- Cut Enables you to remove a selected signal from the list and place it on the "clipboard" in the projector.
- Copy Enables you to copy a selected signal from the list and place it on the "clipboard" in the projector.
- Paste Enables you to paste the signal placed on the "clipboard" to any other line of the list. To do this, select "Paste" and then select the line number you want to paste to. Last press ENTER.
- Edit Enables you to change source names or add source names to "More" in the Source Select.
 - Source Name .. Enter a signal name. Up to 18 alphanumeric characters can be used.
 - Input Terminal .. Change the input terminal. RGB1 and RGB2 are available for RGB signal; Video and S-Video are available for composite signal.
 - Source List Set signal selection method.
 - Lock Set so that the selected signal cannot be deleted when "All Delete" is executed.
 - Skip Set so that the selected signal will be skipped during auto search.

When complete, select OK and press ENTER. To exit without storing setting, select Cancel. Select "Source Name" and press ENTER to display the Source Name Edit window. You can change source name on this window. Press [▼] to display the software keyboard, which you can enter alphanumeric characters. See page E-64 for the key function of the software keyboard.

- All Delete This feature enables you to delete all the registered signals in the Entry List.

The following buttons are not available for the currently projecting signals:

- 1) The Cut and Paste buttons on the Entry Edit Command screen
- 2) The Input Terminal button on the Entry Edit screen

Picture (not available for Viewer and LAN)

Adjusting Brightness, Contrast, Color, Hue, and Sharpness

- Brightness Adjusts the brightness level or the back raster intensity.
- Contrast Adjusts the intensity of the image according to the incoming signal.
- Color Increases or decreases the color saturation level (not valid for RGB).
- Hue Varies the color level from +/- green to +/-blue. The red level is used as reference. This adjustment is only valid for Video and Component inputs (not valid for RGB).
- Sharpness Controls the detail of the image for Video (Not valid for RGB).

Sound

Controlling Volume, Bass and Treble.

Adjusts the sound, bass and treble level of the projector speaker and AUDIO OUT (RCA).

Image Options

Selecting Aspect Ratio (not available for Viewer and LAN)

Aspect Ratio allows you to select the best Aspect mode to display your source image.

When screen size 4:3 is selected for the source, the following selections will display:

- 4:3 Standard 4:3 aspect
- Letter Box Reduced to display the true aspect with black borders on top and bottom
- Wide Screen .. Left & Right stretched with black borders on top and bottom
- Crop Left & Right stretched.
Left & Right sides cut. Available for 4:3 only.

When screen size 16:9 is selected for the source, the following selections will display:

- 4:3 Window Reduced to display the true aspect with black borders on right and left
- Letter Box Standard 16:9 aspect
- Wide Screen .. Left and right stretched to display the true aspect
- 4:3 Fill Stretched to display in 16:9 aspect ratio

NOTE: You can adjust image positions vertically for source with black borders. See page E-49 for setting image positions.

Copyright

Please note that using this projector for the purpose of commercial gain or the attraction of public attention in a venue such as a coffee shop or hotel and employing compression or expansion of the screen image with a "Aspect Ratio" or "Screen" setting may raise concern about the infringement of copyrights which are protected by copyright law.

NOTE: During 3D Reform adjustment, "Aspect Ratio" may not be available. Should this happen, first reset the 3D Reform data and then do setting again. Second repeat the 3D Reform adjustment.

Changing the aspect ratio can limit 3D Reform in its adjustable range.

Input Signal / Screen Type	4:3	Letterbox	Squeeze
4:3 Screen	4:3	Letterbox	Wide Screen Crop
16:9 Screen	4:3 Window 4:3 Fill	Letterbox	Wide Screen

Masking Unwanted Area (Blanking)

This feature allows you to mask any unwanted area of the screen image.

Adjust the Top, Bottom, Left or Right blanking with the SELECT ◀ or ▶ button.

Adjusting Position and Clock

This allows you to manually adjust the image horizontally and vertically, and adjust Clock and Phase.

Horizontal/Vertical Position:

Adjusts the image location horizontally and vertically using the SELECT ◀ and ▶ buttons. This adjustment is made automatically when the Auto Adjust is turned on. See "Auto Adjust" on page E-47 for turning on or off the Auto Adjust feature.

Clock Use this item to fine tune the computer image or to remove any vertical banding that might appear. This function adjusts the clock frequencies that eliminate the horizontal banding in the image.

Press the SELECT ◀ and ▶ buttons until the banding disappears. This adjustment may be necessary when you connect your computer for the first time. This adjustment is made automatically when the Auto Adjust is turned on.

Phase Use this item to adjust the clock phase or to reduce video noise, dot interference or cross talk. (This is evident when part of your image appears to be shimmering.) Use the SELECT ◀ and ▶ buttons to adjust the image.

Use "Phase" only after the "Clock" is complete. This adjustment is made automatically when the Auto Adjust is turned on.

Selecting Resolution

This allows you to activate or deactivate the Advanced AccuBlend feature.

Auto Turns on the Advanced AccuBlend feature. The projector automatically reduces or enlarges the current image to fit the full screen.

Native Turns off the Advanced AccuBlend feature. The projector displays the current image in its true resolution.

See "Auto Adjust" on page E-47 for turning on or off the Auto Adjust feature.

NOTE:

* When "Resolution" is set to "Native", "3D Reform", "Aspect Ratio", "Screen" and "Overscan" are not available.

* While you are displaying an image with higher resolution than the projector's native resolution, "Resolution" is not available.

Selecting Overscan Percentage

Select overscan percentage (0%, 5%, 10% and 25%) for signal.

NOTE: When "Resolution" is set to "Native", this feature is not available, and the stored settings and adjustments are invalid.

NOTE: When "4:3 Fill" or "Crop" is selected in "Aspect Ratio", this feature is not available.

Selecting Video Filter Level (not available for Video, Viewer and LAN)

This function reduces video noise.

Off The filter is removed.

Less The low-pass filter is applied partially.

More The low-pass filter is applied fully.

Selecting Noise Reduction Level (not available for RGB, Viewer and LAN)

Select one of the three levels for reducing video noise: Low, Medium or High.

NOTE: The lower the Noise Reduction level, the better the image quality by way of higher video bandwidth.

Signal Type

Select either the RGB signal type or the Component signal type.

RGB RGB signal

Component Component signals such as Y/Cb/Cr, Y/Pb/Pr

NOTE: This feature is available on RGB 1 and 2 only. If you do not get a better picture even when you set "Signal Select" to "Component" in Setup, set this to "Component".

Picture Management

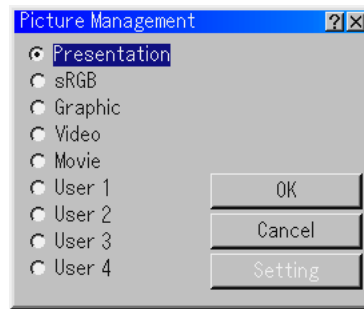

This option allows you to adjust neutral tint for yellow, cyan or magenta. There are 5 factory presets optimized for various types of images, or you can set 4 user adjustable settings.

Presentation .. Recommended for making a presentation using a PowerPoint file

sRGB Standard color values

Graphic Recommended for graphics

Video Recommended for regular picture such as TV program

Movie Recommended for movie

User 1-4 User adjustable

NOTE: When "sRGB", "Graphic", "Video" or "Movie" is selected, the brightness decreases slightly when compared to "Presentation". This is not a malfunction.

User Adjust (when using User 1 to 4)

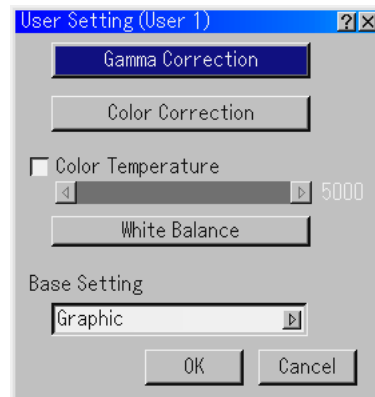

When selecting one of four user adjustable presettings (User 1 through 4), the submenu will be displayed.

You can customize each gamma or color. To do so, first select [Setting] and press the ENTER button, and then proceed the following steps.

Selecting Gamma Correction Mode

Use the ◀ or ▶ buttons to choose one mode from three options.
Each mode is recommended for :

- Dynamic For true color reproduction of natural tones
- Natural Normal settings
- Black Detail For dark portions of a picture

Selecting Color Correction

Adjusts red, green, blue, yellow, magenta, cyan and color gain each independently to correct the tint on whole screen.

Adjusting Color Temperature and White Balance

This feature adjusts the color temperature using the slide bar.

Checking "Color Temperature" enables the color temperature slide bar and disables the "White Balance" button.
Clear "Color Temperature" and press the White Balance button to access the Contrast/Brightness adjustment for each R, G, and B.

NOTE: "Color Temperature" and "White Balance" are a trade-off.
The White Balance is not available for Viewer and LAN.

Selecting Base Setting

This feature allows you to use color correction or gamma values as reference data to optimize for various types of images. You can select one of the following five settings.

- Presentation
- sRGB
- Graphic
- Video
- Movie

Projector Options

Using 3D Reform

This feature corrects trapezoidal distortion so that the projected image is rectangular.
Two options are available for correcting procedures.
You can save adjustment settings by using the 3D Reform Save option on Setup (See page E-47).

Cornerstone

See page E-20.

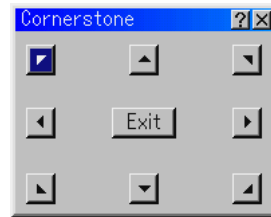

Keystone

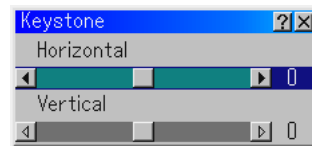

1. Press the SELECT ◀▶ button to adjust the horizontal keystone.
2. Press the SELECT ▲▼ button to select "Vertical".
3. Press the SELECT ◀▶ button to adjust the vertical keystone.
4. After completing, press the ENTER button. This will return to the menu screen.

* When "Resolution" is set to "Native", "Cornerstone" and "Keystone" are not available.

Keystone Correction at Zoomed Lens Position

You can zoom in or out, while keeping an image that was corrected using Keystone, without again having to make those adjustments.

Improvements in 3D Reform performance allows the projector's adjustment range (horizontal and vertical combinations) to be wider by approximately 25% in the maximum telephoto position when compared to initial units shipped.

NOTE: There are some cases when adjusting the zoom position from Tele to Wide (after performing Keystone correction in Tele) can result in a message "Range Over ! 3D Reform data has been cleared.". In this case correction values for Keystone will return to the factory default setting.

Using Adapting Color Correction [Wall Color Correction]

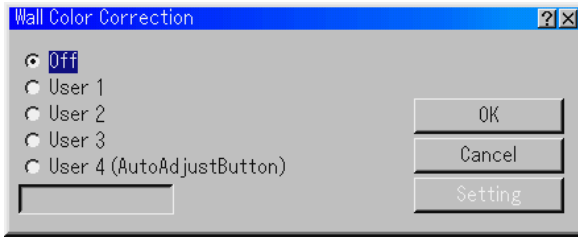

This function allows for correcting the color of the projected images on textured walls using the image sensor on the projector. There are two ways for color correction: Automatic and Manual. Automatic correction affects all colors; Manual correction allows you to correct each color R, G, B, and W respectively.

- Off Disables this function
- User 1 to 4 Executes correction. Four settings can be saved. User 4 (AutoAdjustButton) stores settings when the Auto Function is executed by pressing and holding the AUTO ADJUST button or AUTO ADJ. button for a minimum of 2 seconds.
- Info box Displays "Automatic" or "Manual". This is the option you have set for User 1 – 4 setting.

NOTE: Correction may not be possible depending on ambient room lighting, walls with a texture that is glossy or with certain patterns, or walls that are the color black or primary deep colors. If you try to correct beyond the limit, an error message "Out of correction range!" will be displayed. This message means that you will not be able to correct the color due to the above reasons.

Also, When the image sensor fails to pick up the image of a wall color during Auto Wall Color Correction, an error message "Failed to execute Auto Wall Color Correction" will be displayed. This message means that there may be an obstacle between the wall and the image sensor on the projector, or the image sensor may not work because of too much ambient light. Make corrections to what seems to be the problem and try again.

Automatic Wall Color Correction

1. Choose a selection from User 1 – 4. Highlight "Setting" and press the ENTER button.

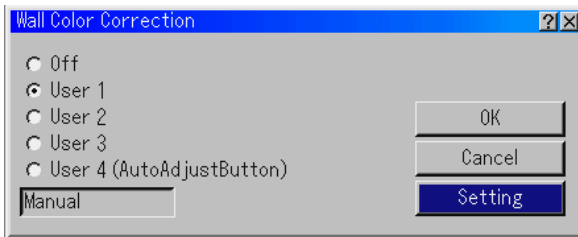

The correction mode select screen will be displayed.

- * To read the pre-adjustment settings. Choose a selection from User 1 – 4, highlight "OK" and press the ENTER button.

2. Highlight "Automatic".

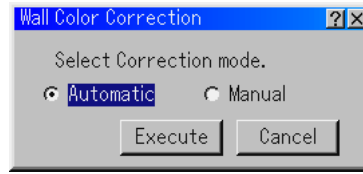

3. Use the SELECT▼ button to highlight "Execute" and then press the ENTER button. The Auto Wall Color Correction will be executed.

NOTE: When Auto Wall Color Correction is enabled in the Auto Functions menu, Wall Color Correction can be executed by pressing and holding the AUTO ADJUST or AUTO ADJ button for a minimum of 2 seconds.

Manual Wall Color Correction

Preparation: Before correcting manually, prepare a non-glossy, non-transparent, clean white paper (300 mm × 420 mm). Hereafter referred to as "the white paper for Wall Color Correction."

1. Choose a selection from User 1 – 4. Highlight "Setting" and press the ENTER button. The correction mode select screen is displayed.
 - * To read the pre-adjustment settings. Choose a selection User 1 – 4, highlight "OK" and press the ENTER button.
2. Highlight "Manual".

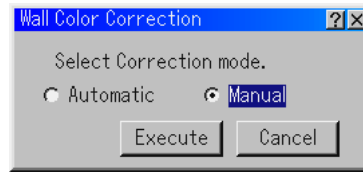

3. Use the SELECT▼ button to highlight "Execute" and then press the ENTER button. The Manual Wall Color Correction (Red) screen will be displayed.

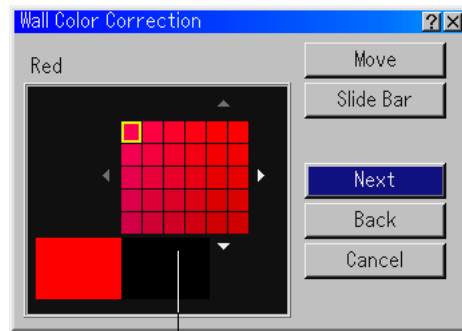

Working area

- Place the white paper for Wall Color Correction over the working area in the Manual Wall Color Correction (Red) screen.
Paste the white paper loosely or get someone to hold it.

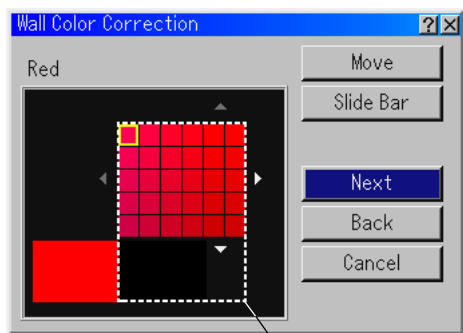

Position of the white paper for Wall Color Correction

NOTE: The size of the above Manual Wall Color Correction screen changes depending on the screen size.

- Use the SELECT ◀ or ▶ button to move the blue frame to the working area and then press the ENTER button. A yellow box will appear in the palette.

- To move the Manual Wall Color Correction (Red) screen, highlight "Move" and then press the ENTER button.
- The "Slide Bar" button adjusts Hue, Saturation and Brightness.

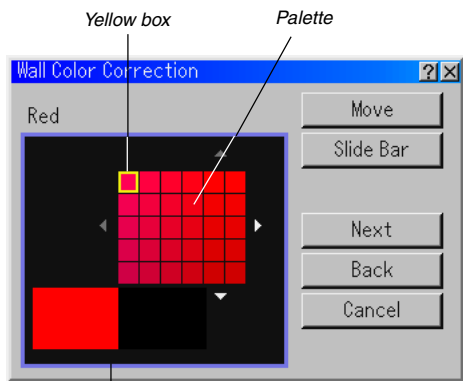

Blue frame

- Use the SELECT ▲▼◀▶ button to move the yellow box to select a color density.

Moving the yellow box changes the color density of the selected portion in the palette.

Move the yellow box so that a color on the white paper for Wall Color Correction becomes close to a color of the projected image on the wall.

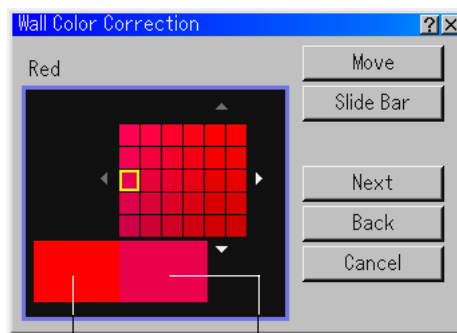

Actual color of the projected image on the wall

Color of the projected image on the white paper for Wall Color Correction

- When you complete the correction, press the ENTER button. The "Next" will be highlighted.
- Press the ENTER button. The Manual Wall Color Correction (Green) screen will be displayed.
- Repeat steps 4 to 8. Adjust Red, Green, Blue and White respectively. When you complete correcting White, the Exit Adjustment screen is displayed.

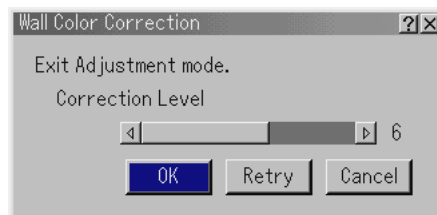

- Highlight the Correction Level bar and then use the SELECT ◀ or ▶ button to finely adjust.

- Highlight "OK" and press the ENTER button.

Menu

Allows you to set preferences for the on-screen menu. Press "OK" to save your changes for all the features of Page 1 and Page 2.

[Page1]

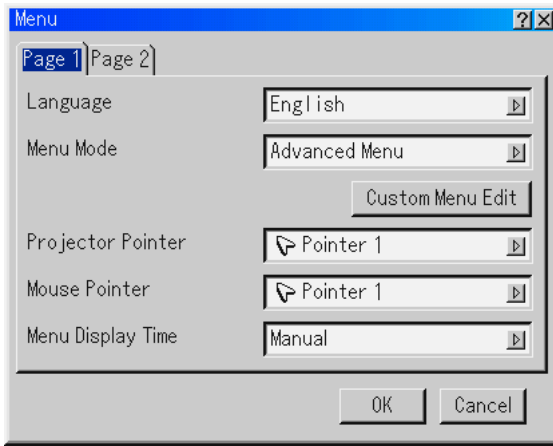

Selecting Menu Language [Language]:

You can choose one of seven languages for on-screen instructions. The options are: English, German, French, Italian, Spanish, Swedish and Japanese.

Selecting Menu Mode [Menu Mode]:

This feature allows you to select 3 menu modes: Advanced Menu, Custom Menu and Basic Menu.

Advanced Menu This is the menu that contains all the available menus and commands.

Basic Menu This is the basic menu that contains minimum essentials of menus and commands.

Custom Menu This is the menu that you can customize using the Custom Menu Edit to fit your needs.

Customizing the Menu:

See page E-34 for instructions about how to customize the Menu.

Selecting Projecting Pointer Icon [Projector Pointer]:

This enables you to select from nine different Pointer icons for the "Pointer" button on your remote control.

After moving your Pointer icon to the area you want on the screen, press the Magnify button on the remote control to enlarge the selected area on the screen. See page E-27 for more details.

NOTE: There may be cases where the Pointer function is not available (ex. a non-interlace signal at 15kHz such as video game.)

Selecting a Mouse Pointer Icon [Mouse Pointer]:

This option enables you to select one of nine different mouse pointers when using a USB mouse.

Selecting Menu Display Time:

This option allows you to select how long the projector waits after the last touch of a button to turn off the menu.

The preset choices are "Manual", "Auto 5 sec", "Auto 15 sec", and "Auto 45 sec". The "Auto 45 sec" is the factory preset.

Manual The menu can be turned off manually.

Auto 5 sec The menu will automatically be turned off in 5 seconds if no buttons are pressed within 5 seconds.

Auto 15 sec The menu will automatically be turned off in 15 seconds if no buttons are pressed within 15 seconds.

Auto 45 sec The menu will automatically be turned off in 45 seconds if no buttons are pressed within 45 seconds.

[Page 2]

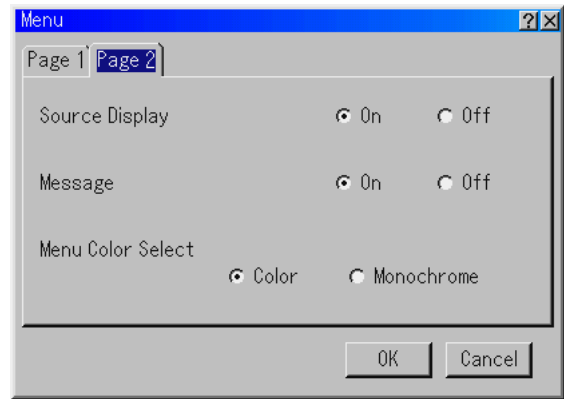

Turning On / Off Source Display [Source Display]:

This option turns on or off input name display such as RGB1/2, Video, and No Input to be displayed in the top right corner of the screen.

Turning On / Off Message [Message]:

This option turns on and off messages for lamp life warning, 3-minute before power off time, "Please clean filter" and "Please wait a moment".

Selecting Menu Color [Menu Color Select]:

You can choose between two color modes for menu color: color and monochrome.

Setup

Enables you to set operating options.
 Press "OK" to save your changes for all the features of Page1, Page2,
 Page3, Page 4, Page 5 and Page 6.

[Page 1]

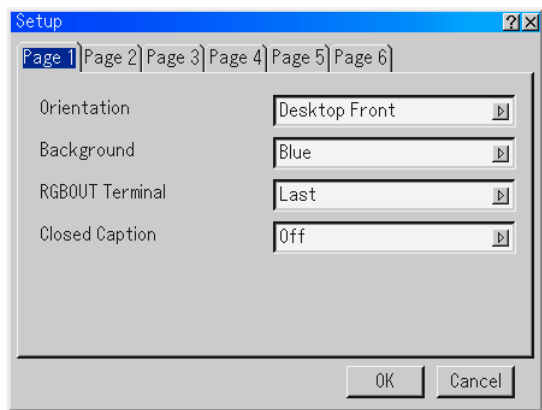

Selecting Projector Orientation [Orientation]:

This reorients your image for your type of projection. The options are: desktop front projection, ceiling rear projection, desktop rear projection, and ceiling front projection.

Selecting a Color or Logo for Background [Background]:

Use this feature to display a blue/ black screen or logo when no signal is available. The default background is "Blue". You can change the logo screen using the PC Card Files feature. See page E-29.

Setting RGB 1 or 2 for RGB OUT [RGBOUT Terminal]:

This option allows you to determine which RGB source is output from the RGBOUT connector during Idle mode.

- Last The signal from the last RGB input will be output to the RGBOUT connector.
- RGB 1 The signal from RGB1 IN will be output to the RGBOUT connector.
- RGB 2 The signal from RGB2 IN will be output to the RGBOUT connector.

NOTE: The AUDIO OUT mini jack will not output sound during the Idle mode.

Setting Closed Caption:

This option sets several closed caption modes that allows text to be superimposed on the projected image.

- CAPTION 1-4 Text is superimposed.
- TEXT 1-4 Text is displayed in full screen.
- OFF This exits the closed caption mode.

[Page 2]

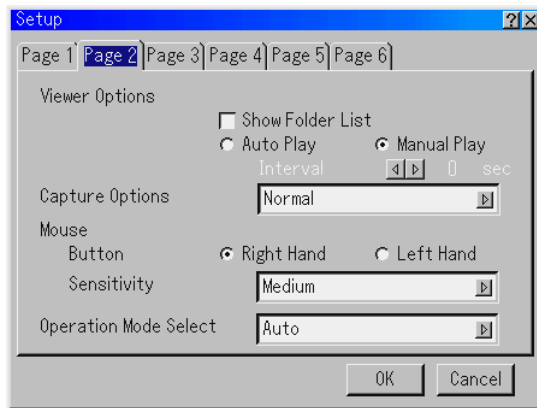

Setting Viewer Options [Viewer Options]

Show Folder List:

If this option is checked, when the Viewer source is selected on the projector, the folder lists will be displayed and allows you to select the presentation from a PC card.

Auto Play:

If this option is checked, when the Viewer source is selected on the projector any given slide will start to play automatically.

Auto Play Interval:

You can specify interval time between 5 and 300 seconds.

NOTE: The Auto Play Interval time set on "Slide Show Settings" of the Dynamic Image Utility 2.0 overrides the one set here.

Manual Play:

Views a slide manually when the Viewer source is selected.

Selecting Capture Options [Capture Option]: (available for JPEG only)

These options are used for the Capture function that you can select from Tools. You have three options for JPEG compression quality: High quality, Normal and High Compression.

- High Quality Gives quality of JPEG a priority.
- Normal Gives normal JPEG quality.
- High Compression Gives compression a priority.

Setting Mouse Button and Sensitivity [Mouse]:

This option lets you to change your USB mouse settings. The mouse settings feature is available for USB mouse only. Choose the settings you want:

- Mouse Button "Right Hand" or "Left Hand"
- Mouse Sensitivity "Fast", "Medium" or "Slow"

Selecting Operation Mode [Operation Mode Select]

Set the operation mode of the USB mouse connected to the USB port (MOUSE/HUB) on the projector

Auto Depending on connection of the USB port (PC) on the projector and a USB port (type A) on your PC, the USB mouse is operated in the following way:

- * When connecting the projector to your PC
 The USB mouse connected to the projector can be used as a PC mouse.
- * When not connecting the projector to your PC
 The USB mouse connected to the projector can perform menu operation of the projector.

Projector The USB mouse connected to the projector can perform menu operation of the projector.

[Page 3]

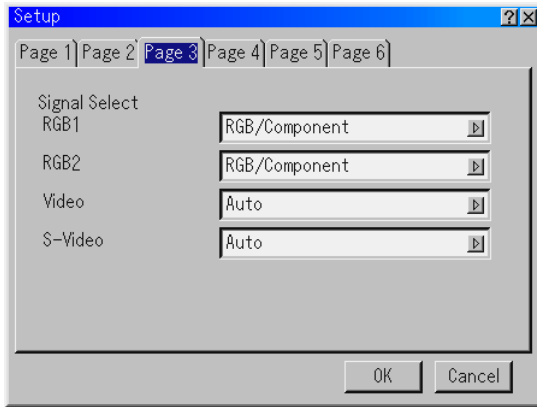

Selecting Signal Format [Signal Select]

RGB1/2:

Allows you to choose "RGB" for an RGB source such as a computer, or "Component" for a component video source such as a DVD player. Normally select "RGB/Component" and the projector automatically detects an either incoming signal. However there may be some component signals that the projector is unable to detect. If this is the case, select "Component". Select "Scart" in RGB 1 or 2 for the European Scart.

VIDEO and S-VIDEO:

This feature enables you to select composite video standards manually. Normally select "Auto". Select the video standard from the pull-down menu. This must be done for Video and S-Video separately.

[Page 4]

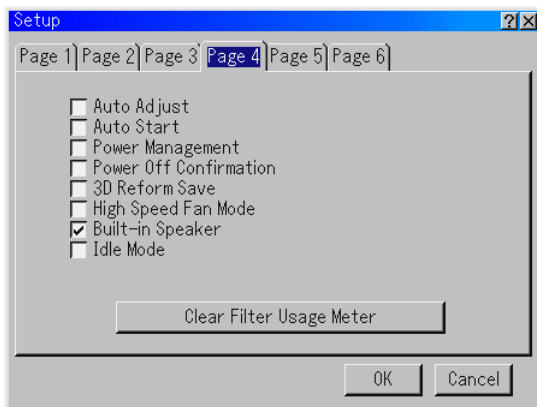

Enabling Auto Adjust [Auto Adjust]:

When "Auto Adjust" is set to "On", the projector automatically determines the best resolution for the current RGB input signal to project an image using NEC's Advanced AccuBlend Intelligent Pixel Blending Technology. The image can be automatically adjusted for position and stability; "Horizontal Position", "Vertical Position", "Clock", "Phase", and "Resolution".

On Automatically adjusts image "Horizontal Position", "Vertical Position", "Clock", "Phase" and "Resolution".

Off User can adjust the image display functions ("Horizontal Position", "Vertical Position", "Clock", "Phase" and "Resolution") manually.

Enabling Auto Start [Auto Start]:

Turns the projector on automatically when the power cable is inserted into an active power outlet and the main power switch is turned on. This eliminates the need to always use the "Power" button on the remote control or projector cabinet.

Enabling Power Management [Power Management]:

When this option is on and there is no input for five minutes or more, the projector will automatically turn itself off.

Enabling Power Off Confirmation [Power Off Confirmation]:

This option determines whether a confirmation dialog for turning off the projector will appear or not.

NOTE: When the confirmation message is displayed, you must be in the Projector mode to operate your projector using the remote control. If not, press the PJ button on the remote control to change your projector to the Projector mode. The button lights to indicate that you are in the Projector mode.

Enabling Horizontal and Vertical Keystone Correction Save

[3D Reform Save]:

This option enables you to save your current 3D Reform settings. Saving your change once affects all sources. The changes are saved when you turn off the projector.

Enabling High Speed Fan Mode [High Speed Fan Mode]:

This option allows you to select two modes for fan speed: high-speed mode and normal speed mode.

When you wish to cool down the temperature inside the projector quickly, check this box.

NOTE: Enable High Speed Fan mode if you continue to use the projector for consecutive days.

Selecting Built-in Speakers [Built-in Speaker]:

This option allows you to mute the built-in speakers.

Enabling Idle Mode [Idle Mode]:

The projector has two standby modes: Standby and Idle. Standby is the mode that allows you to put the projector in the standby condition which consumes less power than the idle mode. The projector is preset for Idle mode at the factory. When this check box is turned on, you allow the RGB OUT connector to output RGB signal during Idle mode.

NOTE:

- * The RGB OUT connector will not output signal during the Standby mode.
- * Via the USB interface the projector can be turned on from your PC using Dynamic Image Utility 2.0 during the Standby or Idle mode. On the LAN connection the projector can be controlled or monitored from your PC using Dynamic Image Utility 2.0 only in the Idle mode.
- * The HTTP server functions are not available during Standby mode.

Resetting the Filter Usage Hours [Clear Filter Usage Meter]:

Resets the filter usage back to zero. Pressing this button appears a confirmation dialog box. To reset the filter usage hours, press "OK".

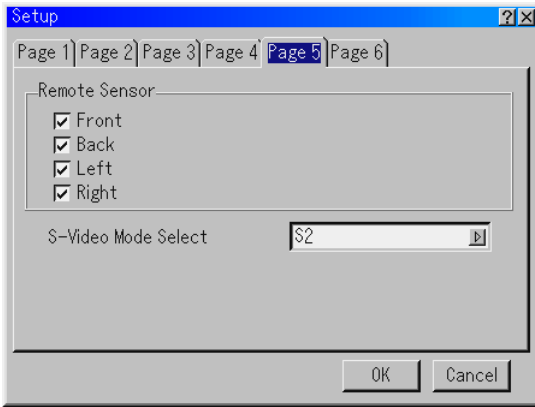

Remote Sensor:

This option determines which remote sensors on the projector are enabled in wireless mode.

The options are: front, rear, right, or left. All checked boxes indicate that they can accept the infrared signal from the supplied remote control.

S-Video Mode Select:

This feature is used to select the S-Video signal detection mode. This allows identifying of the S-Video signals with different aspect ratio (16:9 and 4:3).

- Off Does not identify any S-video signal.
- S2 Identifies the 16:9 or 4:3 signal.

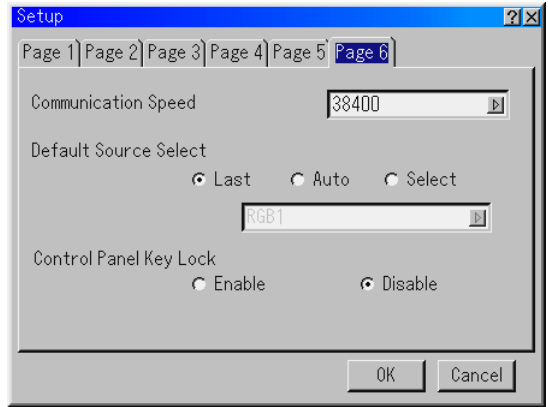

Selecting Communication Speed [Communication Speed]:

This feature sets the baud rate of the PC Control port (D-Sub 9 Pin). It supports data rates from 4800 to 38400 bps.

The default is 38400 bps. Select the appropriate baud rate for your equipment to be connected (depending on the equipment, a lower baud rate may be recommended for long cable runs).

Selecting Default Source [Default Source Select]:

You can set the projector to default to any one of its inputs each time the projector is turned on.

- Last Sets the projector to default to the previous or last active input each time the projector is turned on.
- Auto Searches for an active source in order of RGB1 → RGB2 → Video → S-Video → DVI(DIGITAL) → Viewer → RGB1 and displays the first found source.
- Select Displays the selected source input every time the projector is started up. Select an input from the pull-down menu.

Disabling the Cabinet Buttons [Control Panel Key Lock]:

This option turns on or off the Control Panel Key Lock function.

NOTE:

- * This Control Panel Key Lock does not affect the remote control and the PC Control functions.
- * When the cabinet buttons are disabled, pressing and holding the CANCEL button for about 10 seconds will change the setting to enabled.

Selecting Lamp Mode and Lamp Type [Lamp Setting]

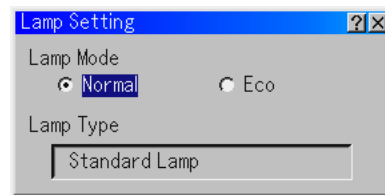

Lamp Mode:

This feature enables you to select two brightness modes of the lamp: Normal and Eco modes. The lamp life can be extended by using the Eco mode.

- Normal Mode . This is the default setting (100% Brightness).
- Eco Mode Select this mode to increase the lamp life (80% Brightness).

Lamp Type:

- The lamp type you use is displayed here.
- 456-8946 Standard life lamp (8946)
- 456-8805 Standard life lamp (8805)
- MT60LPS Optional extended life lamp. When the optional extended life lamp is used, the Lamp Mode is available.

Selecting Aspect Ratio and Position for Screen [Screen]

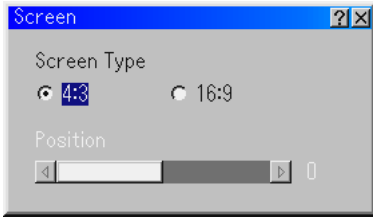

Screen Type:

Select either 4:3 Screen or 16:9 Screen for the screen to be used. See also "Aspect Ratio" on page E-40.

NOTE: When "Resolution" is set to "Native", this selection is inactive.

Position:

This feature adjusts the vertical position of the image when viewing video with an aspect ratio selected. When some aspect ratios are selected in Image Options, the image is displayed with black borders on the top and bottom. You can adjust the vertical position between top and bottom.

NOTE: This option is not available when "4:3" is selected in Screen Type and "Letterbox" is selected in Aspect Ratio.

NOTE: During 3D Reform adjustment, "Screen Type" and "Screen Position" may not be available. To make available, first reset the 3D Reform data and then do settings again. Secondly repeat the 3D Reform adjustment. Changing "Screen Type" and "Screen Position" can limit 3D Reform in its adjustable range.

Selecting Auto Functions

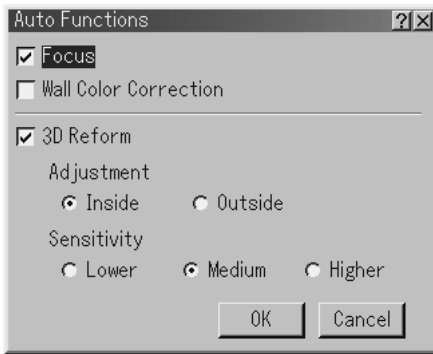

Focus:

When Auto Focus is enabled in the Auto Functions menu, Auto Focus can be executed by pressing and holding the AUTO ADJUST or AUTO ADJ button for a minimum of 2 seconds.

Wall Color Correction:

When Wall Color Correction is enabled in the Auto Functions menu, Wall Color Correction can be executed by pressing and holding the AUTO ADJUST or AUTO ADJ button for a minimum of 2 seconds. Correction settings will be saved on "User 4 (AutoAdjustButton)".

3D Reform:

Auto 3D Reform automatically corrects distortion by sensing the outline or outer frame of your screen with the projector's built-in image sensor to project an image within the screen. See page E-26.

NOTE:

1. If neither Focus or Wall Color Correction are enabled in the Auto Functions menu when you press and hold the AUTO ADJUST or AUTO ADJ button for a minimum of 2 seconds, the Auto Adjust function (Position/Clock/Phase) will be performed instead of Auto Focus and Auto Wall Color Correction.
 2. Due to specifications of the image sensor on the projector, Auto Functions are effective to image sizes between 40" and 150" (diagonal). Also in some cases Auto Functions may not work correctly depending on projection conditions such as textured material of the screen or ambient light.
-

Setting LAN Mode

This feature allows you to set various setting items when the projector is used on your network.

Consult with your network administrator about these settings.

NOTE:

- A LAN card is required for LAN connection; NEC's optional wireless LAN card is available. For more information on inserting or ejecting a LAN card, see page E-30.
- Either PC Card Slots 1 or 2 can accept LAN card. If two LAN cards are inserted into both PC card slots, the first inserted one is effective.

CAUTION: Make sure that the LAN card is removed during Standby mode (NOT Idle mode) or with the main power off.

Failure to do so may cause damage to the data on your PC card.

IP Address

An IP address can be automatically assigned to this projector by your DHCP server. If your network does not automatically assign IP address, ask your network administrator for an address, and then register it manually.

- Automatic Automatically assigns an IP address to the projector from a DHCP server.
- Manual Provides a space for you to register the IP address or subnet mask number obtained from your network administrator.
- IP Address Set your IP address. Press to display the software keyboard and type in 12 numeric characters.
- Subnet Mask .. Set your subnet mask number. Press to display the software keyboard and type in 12 numeric characters.
- Projector Name Specify a unique projector name. Press to display the software keyboard and type in. Up to 16 alphanumeric characters can be used.
- Gateway Set the default gateway of the network connected to the projector. Press to display the software keyboard and type in 12 numeric characters. Checking this box will make the set default route valid. When data is sent from the LAN card, the transfer location will be searched according to the previously set routing information; however, when the transfer location has not been found as a result of the search, the data will be sent to the device that holds the IP address set here. The IP address that is set here must be one that can be identified by a search of the routing information.
- DNS Configuration
..... Type in the IP address of DNS server on the network connected to the projector. 12 numeric characters are used.

Domain Name Type in domain name of the network connected to the projector. Up to 60 alphanumeric characters can be used.

Network Type (required for wireless only)

Mode:

Select communication method when using wireless LAN.

- Infrastructure Select this option when communicating with one or more equipment connected to the wireless or wired LAN network via an access point.
- 802.11 Ad Hoc Select this option when using the wireless LAN to communicate with a computer in a one-to-one correspondence. This is a method that meets the IEEE802.11 wireless standard.
- Ad Hoc Select this option when using the wireless LAN to communicate with a computer in a one-to-one correspondence.
- Easy Connection This allows you to easily set up wireless LAN connection. See the supplied Software Utility Installation Guide for more information.

SSID (Network name):

Enter an identifier (SSID) for wireless LAN. Communication can be done only with equipment whose SSID matches SSID for your wireless LAN. Up to 16 alphanumeric characters can be used (Case-sensitive).

NOTE: To disable SSID, select a space (null) or "ANY"(All caps).

Channel:

Select this option when selecting [802.11 Ad Hoc] or [Ad Hoc] in [Mode]. Select a channel number from the pull-down list. The channel must match for all wireless devices communicating on your wireless LAN.

NOTE: Channels in the pull-down list are different depending on which country you live in.

TX rate:

Select a wireless transmission speed. Normally leave it as Automatic. Try another transmission speed when the connection fails.

WEP (for Wireless only)

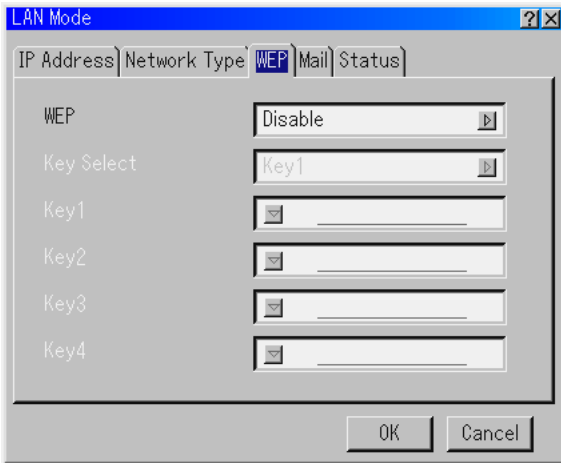

Select this option whether using the WEP (Wired Equivalent Privacy) key for encryption or not. To use encryption, specify WEP key.

- Disable Will not turn on the encryption feature. Your communications may be monitored by someone.
- 64bit Uses 64-bit datalength for secure transmission.
- 128bit Uses 128-bit datalength for secure transmission. This option will increase privacy and security when compared to use of 64bit datalength encryption.

NOTE: The WEP settings must be the same as communication devices such as PC or access point in your wireless network. When you use WEP, your image transmission speed will slow down.

Key Select:

Selects one key from the four keys below when selecting [64bit] or [128bit] in [WEP].

Key1-4:

Enter encryption key when selecting [64bit] or [128bit] in [WEP]. The key can also be set in hexadecimal digit.

- * Enter 0X(numeral and alphabet respectively) right in front of your key code.
- * Hexadecimal uses 0 to 9 and A to F.
- * Up to 5 characters can be set in 64 bit and up to 13 characters in 128 bit.
When setting in a hexadecimal digit, up to 10 characters can be set in 64 bit and up to 26 characters in 128 bit.

Mail

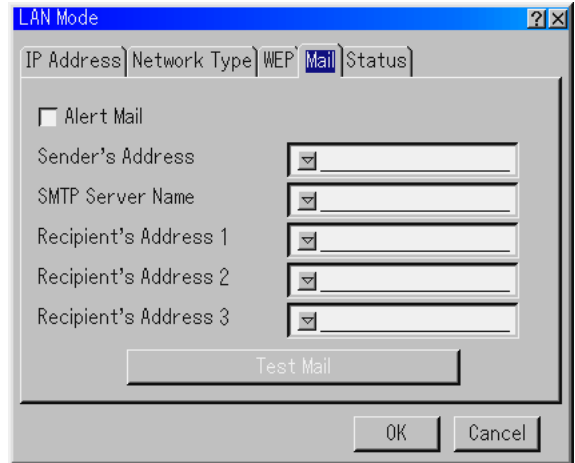

NOTE: To the Mail Alert feature on wireless LAN connection, select "Infrastructure" for "Mode" in "Network Type." "Test Mail" is available only when there is a LAN card in the PC card slot of the projector.

Alert Mail:

Checking this box enables Alert Mail feature.

This option notifies your computer of an error message via e-mail when using wireless or wired LAN. The error message will be notified when the projector lamp has reached the end of its usable life or an error occurs in the projector.

Sample of a message sent from the projector:

The lamp is at the end of its usable life. Please replace the lamp.

Projector Name: X X X X
Lamp Hour Meter: xxxx [H]
Projector Usage: xxxxxx [H]

Sender's Address:

Specify the senders address. Use the Software keyboard. Up to 60 alphanumeric and symbols characters can be used. See "Using Software Keyboard" in Appendix for more details.

SMTP Server Name:

Type in the SMTP server name to be connected to the projector. Up to 60 alphanumeric characters can be used.

Recipient's Address 1 to 3:

Type in your recipient's address. Up to 60 alphanumeric and symbols characters can be used.

Test Mail:

Send a test mail to check if your settings are correct.

NOTE: If you entered an incorrect address in a test, you may not receive an Alert mail. Should this happen, check if the Recipient's Address is correctly set.

NOTE: Unless any one of the "Sender's Address", "SMTP Server's Name" or "Recipient's Address 1-3" is selected, "Test Mail" is not available.

NOTE: Be sure to highlight "OK" and press the ENTER button before executing "Test Mail".

Status

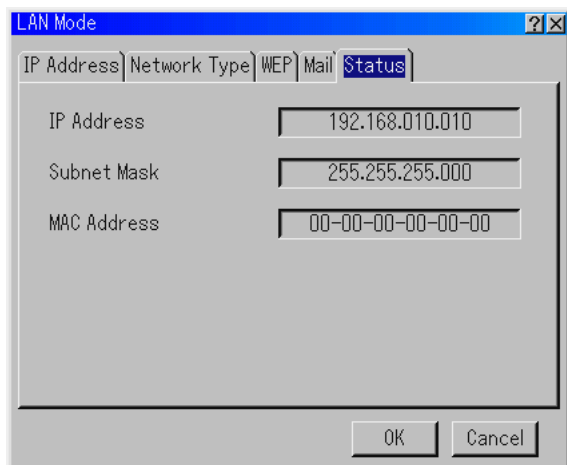

Displays the status of the LAN settings.

- IP Address Indicates the IP address of the projector.
- Subnet Mask .. Indicates the subnet mask of the projector.
- MAC Address . Indicates the MAC address of the LAN card.

Setting a Password

A password can be set for your projector to avoid operation by an unauthorized person.

There are two password options: one for menu and the other for logo. When a password is set, doing any one of the following four operations will display the Password input screen.

For Menu:

- * Changing the menu to Advanced
- * Editing the custom menu

For Logo:

- * Changing the background
- * Changing the logo data in PC Card Files

Procedures for Password setting apply to both Menu and Logo.

Entry

To assign your password:

NOTE: Up to 15 alphanumeric characters can be assigned.

1. Type a password.
Highlight "Entry" and press the ENTER button.

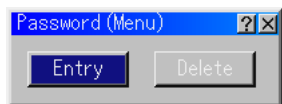

The "Enter the Password screen" will be displayed.

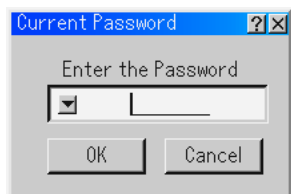

Make sure that "▼" is highlighted and then press the ENTER button. The Software keyboard appears. Use the Software keyboard to type a password and then highlight "OK" on the "Enter the Password" screen and press the ENTER button. The [Confirm Password] screen will be displayed.

2. Type the same password again. Highlight "OK" on the "Enter the Password" screen and press the ENTER button.

Your password will be assigned.

Delete

To delete your password:

1. Highlight [Delete] and press the ENTER button. The "Current Password" screen will be displayed.

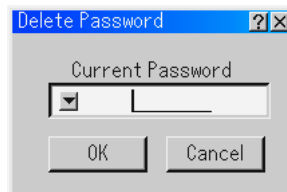

2. Use the Software keyboard to type your password. Highlight "OK" on the "Current Password" screen and then press the ENTER button.

Your password will be deleted.

In case you forget your password, follow the steps below to delete it.

1. Select the Advanced menu from the Basic menu. The "Password" entry screen will be displayed.
2. Use the Software keyboard to type "1111".
Highlight "OK" on the "Password" entry screen and then press the ENTER button.
The "Password Warning!!" message will be displayed.
3. Use the Software keyboard to type "3333".
Highlight "OK" on the "Password" entry screen and then press the ENTER button.
The "Password Warning!!" message will be displayed.
4. Use the Software keyboard to type "5555".
Highlight "OK" on the "Password" entry screen and then press the ENTER button.
The "Delete Password. Are you sure? Yes/No" dialog box will be displayed.
5. Use the SELECT ◀ or ▶ button to highlight "Yes" and press the ENTER button.

Your password will be deleted.

Security

The Security function enables you to protect your projector so that the projector will not project a signal unless you enter a keyword. There is also an option to lock the projector by using a registered PC card as a protect key. Once you have registered your PC card as a protect key, you are required to insert the registered PC card into the PC card slot of the projector each time you turn on the projector. You can enable the Security function by using a keyword only.

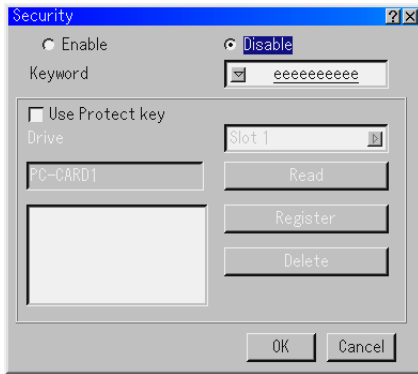

- Enable/Disable This turns the Security function on or off.
- Keyword Enter an appropriate keyword when you use the Security function.
(Up to 10 characters can be used.)
The Security function is available only when your keyword is entered.
- Use Protect key Check this box to lock your projector when using a PC card. To use a keyword without a PC card, do not check this box.
- Drive Switches between PC Card slot 1 and 2.
- Read Reads data of a PC card.
- Register Registers data of the PC card.
The Security function is not available unless at least one PC card is registered. (if the "Use Protect key" check box is selected)
Up to 5 PC cards can be registered.
- Delete Deletes data of a registered PC card.

To set up a keyword to enable the Security function without using a registered PC card.

1. Use the SELECT ▲▼ button to select "Keyword" and use the software keyboard to enter a keyword.

NOTE: Please make a note of your keyword.

2. Use the SELECT ▲▼ button to select "Enable" and use the SELECT ▲▼ button to select "OK", then the Security function will be enabled. An "Are you sure?" message will appear. Use the SELECT ◀▶ button and press the ENTER button.
The Security function takes effect.

To register a PC card as a protect key.

1. Insert a PC card into the PC card slot of the projector.
2. Use the SELECT ▲▼ button to select "Use Protect Key" and press the ENTER button.
3. Use the SELECT ▲▼ button to select "Read" and press the ENTER button.
Data of the PC card will be read into the projector.
4. Use the SELECT ▲▼ button to select "Register" and press the ENTER button.
Downloaded data will be registered and be displayed in the list window.

5. Use the SELECT ▲▼ button to select "Keyword" and use the software keyboard to enter a keyword.

NOTE: To use a PC card as a protect key, you must also set up a keyword. Please make a note of your keyword.

This completes registration of your PC card.

To enable Security, use the SELECT ▲▼ button to select "Enable" and use the SELECT ▲▼ button to select "OK" and "Security function will be enabled. An "Are you sure?" message will appear. Use the SELECT ◀▶ button and press the ENTER button.
The Security function takes effect.

To turn on the projector when Security is enabled (when using your keyword only).

1. Press and hold the POWER button for a minimum of two seconds.
The projector will be turned on and display a message to the effect that the projector is security-protected.
2. Select [Projector Options] → [Security] from the menu and press the ENTER button.
The Release Code input screen will be displayed.
3. Enter your keyword in the Release Code input screen.
You can view the projected image.

NOTE: Do not forget your keyword. However, if you forget your keyword, your dealer will provide you with your Release Code. See more information at the end of this section.

To turn on the projector when Security is enabled (when using a PC card as a protect key).

1. Insert your registered PC card into the PC card slot.
2. Press and hold the POWER button for a minimum of two seconds.
The projector will turn on and then recognize the PC card. Once the image has been projected, it will stay on without the PC card.

- The security disable mode is maintained until the main power is turned off (by setting the main power switch to "O" or unplugging the power cord).

In the following cases you will be asked to check the protect key or input the keyword:

- (1) When "OK" is selected at an image for which security is set and the power is turned off then back on
- (2) When the main power is turned off then back on while the security function is enabled
- (3) When you attempt to display an image for which security is set while the security function is enabled

- Blanks (spaces) cannot be used in the Keyword section.

To delete PC card data you registered.

1. Use the SELECT ▲▼ button to select "Delete" and use the SELECT ◀ button to select the list window.
2. Use the SELECT ▲▼ button to select the PC card data you wish to delete.
3. Press the SELECT ▶ button to select "Delete" and press the ENTER button.
The PC card data will be deleted.

If you've lost your registered PC card, proceed as follows:

NOTE: NEC or your dealer will provide you with your Release Code in exchange for your registered keyword and Request Code. See more information at the end of this section.

1. Press and hold the **POWER** button for a minimum of two seconds.
The projector will be turned on and display a message to the effect that the projector is security-protected.
 2. Select [Projector Options] → [Security] from the menu and press the **ENTER** button.
The Release Code input screen will be displayed as well as your Request Code (24 alphanumeric characters).
 3. Enter your Release Code in the Release Code Input screen.
- * If the projector is turned on by entering the Release Code, your Security will be disabled.

NOTE:

- * Some types of PC cards cannot be registered as your protect key.
- * It is recommended that you register two or more PC cards in case you lose or damage your registered PC card.
- * Formatting your registered PC card will disable your protect key function.

NOTE:

For additional information visit:
US : <http://www.dukcorp.com/av>

Tools

Provides tools for setting sleep timer, capturing images, displaying files or changing your background logo in a PC Card and drawing.

NOTE: The "Capture" and "PC Card Files" features are required for a PC card.

Using Sleep Timer

1. Select your desired time between 30 minutes and 16 hours: Off, 0:30, 1:00, 2:00, 4:00, 8:00, 12:00, 16:00.
2. Select "Set" and press the **ENTER** button on the remote control.
3. The remaining time starts counting down.
4. The projector will turn off after the countdown is complete.

NOTE:

- To cancel the preset time, set "Off" for the preset time or turn off the power.
- When the remaining time reaches 3 minutes before the projector is turned off, the "Projector will turn off in 3 minutes" message will be displayed on the bottom of the screen.

Using Capture

Allows you to capture an image from a source that is currently being displayed. The image is saved as JPEG in the PC card. When you select Capture from the menu, you will get a tool bar. You can capture an image directly using the tool bar when the menu is not displayed. See page E-32.

Using PC Card Files

The PC Card Files feature allows you to display a list of all the files stored in the PC card so that you can select a file you want to display. You can also sort files by file name or date, or display the file. See page E-33.

Changing Background Logo:

You can change the default background logo using the PC Card Files feature.

NOTE: File size must be 256KB or less. Other file formats than JPEG and BMP are not available. See page E-29.

Using ChalkBoard

The ChalkBoard feature allows you to write and draw messages on a projected image. See page E-29.

NOTE: This feature is available only when using with a USB mouse. See page E-28.

Help

Contents

Provides an online help about how to use the menus. An underlined link means that you can move to an adjustment item directly. Selecting the underlined link and pressing **ENTER** moves to the corresponding adjustment item.

Information

Displays the status of the current signal, and the lamp and the projector usage hours. This dialog box has 4 pages. The information included are as follows:

[Page 1]	[Page 2]	[Page 3]
Source Name	Signal Type	Remaining Lamp Time (%)
Input Terminal	Video Type	Lamp Hour Meter (H)
Entry No.	Sync Type	Filter Usage (H)
Horizontal Frequency	Interlace	Projector Usage (H)
Vertical Frequency		
Sync Polarity		

[Page 4]

Version (BIOS, Firmware, Data)

NOTE: The progress indicator shows the percentage of remaining bulb life. The value informs you of the amount of lamp and projector usage respectively.

Remaining Lamp Time Display

When the remaining lamp time reaches 0, the Remaining Lamp Time bar indicator changes from 0% to 100 Hours and starts counting down. If the remaining lamp time reaches 0 hours, the projector will not turn on regardless of whether the lamp mode is set to Normal or Eco.

Returning to Factory Default

The Factory Default feature allows you to change adjustments and setting to the factory preset for source except the following:

All Data Reset all the adjustments and settings for all the signals to the factory preset except Remaining Lamp Time, Lamp Hour Meter, Filter Usage, Projector Usage, Language, Background, Idle mode, Communication Speed, LAN Mode, Security and Password.

Including Entry List:

Also deletes all the signals in the Entry List and returns to the factory preset.

Current Signal Resets the adjustments for the current signal to the factory preset levels.

All the items in "Picture", "Sound", "Image Options" and "Picture Management" can be reset.

MAINTENANCE

This section describes the simple maintenance procedures you should follow to replace the lamp and the filter, and to clean the filter, the cabinet and the lens.

Replacing the Lamp

After your lamp has been operating for 2000 hours (Normal mode on the standard life lamp) or longer, the "Lamp" indicator in the cabinet will blink red and the message will appear. Even though the lamp may still be working, replace it as soon as possible to maintain optimal projector performance.

CAUTION

- **DO NOT TOUCH THE LAMP** immediately after it has been used. It will be extremely hot. Turn the projector off, wait 90 seconds, turn off the main power switch, and then disconnect the power cable. Allow at least one hour for the lamp to cool before handling.
 - **DO NOT REMOVE ANY SCREWS** except the two lamp case screws. You could receive an electric shock.
 - The projector will turn off and go into stand by mode after 2100 hours (Normal mode on the standard life lamp) of service. If this happens, be sure to replace the lamp. If you continue to use the lamp after 2000 hours (Normal mode on the standard life lamp) of use, the lamp bulb may shatter, and pieces of glass may be scattered in the lamp housing. Do not touch them as the pieces of glass may cause injury.
- If this happens, contact your Dukane dealer for lamp replacement.

To replace the lamp:

NOTE: The optional lamp comes with a flat-head screwdriver.

1. Remove the lamp cover by pushing two grooves lightly with the flat-head screwdriver.

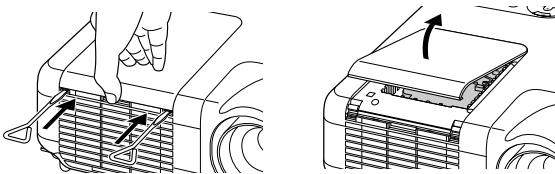

2. Loosen the two screws securing the lamp housing until the screwdriver goes into a freewheeling condition. The two screws are not removable.

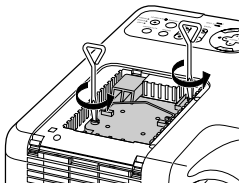

3. Remove the lamp housing by pulling out the handle.

NOTE: There is an interlock on this case to prevent the risk of electrical shock. Do not attempt to circumvent this interlock.

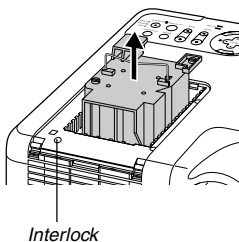

4. Insert a new lamp housing until the lamp housing is plugged into the socket.

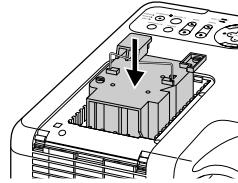

CAUTION: Do not use a lamp other than the Dukane replacement lamp (Standard life lamp: 456-8946 (8946), 456-8805 (8805) or Extended life lamp: MT60LPS).

5. Secure it in place with the two screws. *Be sure to tighten the screws.*

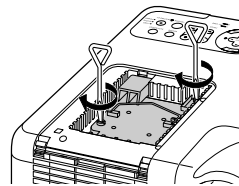

6. Reattach the lamp cover.

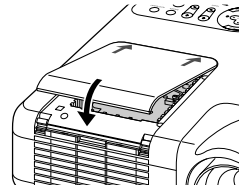

7. Snap the lamp cover into place.

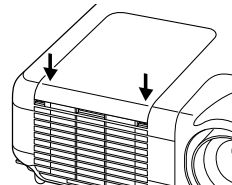

NOTE: Replacing a new lamp automatically clears the lamp usage hours.

NOTE: The lamp housing has an EEPROM chip memorizing its amount of usage hours. You can check the amount usage hours in Information of the menu. (The standard lamp and the optional lamp have an EEPROM chip in it so that when you remove it, your lamp usage hours are saved in its own memory. The projector reads the lamp usage hours from the EEPROM chip to display them in Information of the menu.)

Cleaning

Cleaning or Replacing the Filter

The air-filter sponge keeps the inside of the projector from dust or dirt and should be cleaned after every 100 hours of operation (more often in dusty conditions). If the filter is dirty or clogged, your projector may over-heat.

CAUTION

- Turn off the power and unplug the projector before replacing the filter.
- Only clean the outside of the filter cover with a vacuum cleaner.
- Do not attempt to operate the projector without the filter cover.

To clean the air-filter:

Vacuum the filter-through the filter cover.

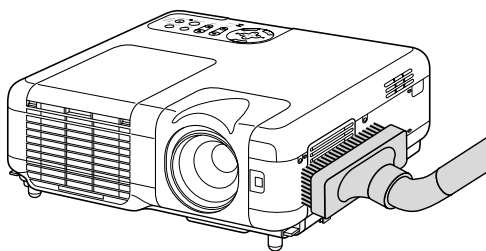

To reset the filter usage time, from the menu, select [Projector Options] → [Setup] → [Page 4] → [Clear Filter Usage Meter] → [OK]. See also page E-47 for resetting the filter usage time.

To replace the filter (sponge):

1. Remove the filter cover by pushing up on the catch of the cover until you feel it detach.

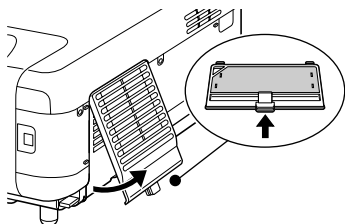

2. Gently peel off the filter (sponge) and replace it with the new one.

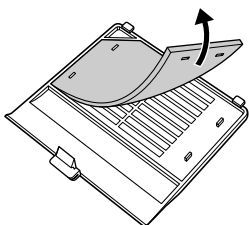

3. Reinstall the new filter cover.

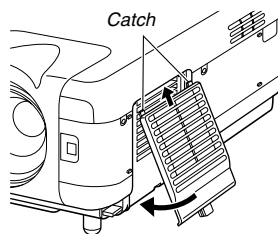

NOTE: Do not wash the filter with soap and water. Soap and water will damage the filter membrane. Before replacing the filter, remove dust and dirt from the projector cabinet. Keep out dust and during filter replacement.

NOTE: When you replace the lamp, it is also wise to replace the filter. The filter comes in the same package with your replacement lamp.

Cleaning the Cabinet and the Lens

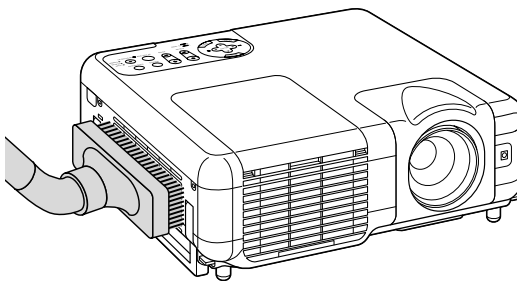

1. Turn off the projector before cleaning.
2. Clean the cabinet periodically with a damp cloth. If heavily soiled, use a mild detergent. Never use strong detergents or solvents such as alcohol or thinner.
3. Use a blower or lens paper to clean the lens, and be careful not to scratch or mar the lens.

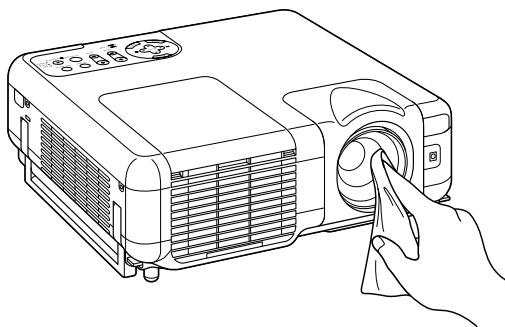

TROUBLESHOOTING

This section helps you resolve problems you may encounter while setting up or using the projector.

Power Indicator

Indicator Condition			Projector Condition	Note
Off			The main power is off	–
Blinking light	Green	0.5 sec ON, 0.5 sec OFF	The projector is getting ready to turn on.	Wait for a moment.
		2.5 sec ON, 0.5 sec OFF	The projector is in Sleep mode.	–
	Orange	0.5 sec ON, 0.5 sec OFF	The projector is cooling down.	Wait for a moment.
Steady light	Green		The projector is turned on.	–
	Orange		The projector is in Standby or Idle.	–

Status Indicator

Indicator Condition			Projector Condition	Note
Off			Normal	–
Blinking light	Red	1 cycle (0.5 sec ON, 2.5 sec OFF)	Lamp cover error or lamp housing error	Replace the lamp cover or lamp housing correctly.
		2 cycle (0.5 sec ON, 0.5 sec OFF)	Temperature error	The projector is overheated. Move the projector to a cooler location.
		3 cycle (0.5 sec ON, 0.5 sec OFF)	Power error	Power unit will not work correctly.
		4 cycle (0.5 sec ON, 0.5 sec OFF)	Fan error	Fans will not work correctly.
		6 cycle (0.5 sec ON, 0.5 sec OFF)	Lamp error	Lamp fails to light. Wait a full minute and then turn on again.
		7 cycles (0.5 sec ON, 0.5 sec OFF)	Fails to read lamp data	Contact your dealer.
	Green		Re-firing the lamp	The projector is re-firing.
Steady light	Orange		Control key locked	You have pressed control panel key when Control Key Lock is enabled.
	Green		Idle condition	–

Lamp Indicator

Indicator Condition			Projector Condition	Note
Off			Normal	–
Blinking light	Red		Lamp has reached its end of life. Lamp replacement message will be displayed.	Replace the lamp.
Steady light	Red		Lamp has been used beyond its limit. The projector will not turn on until the lamp is replaced.	Replace the lamp.
	Green		Lamp mode is set to Eco mode	–
	Orange		Extended life lamp is used	–

Common Problems & Solutions

Problem	Check These Items
Does not turn on	<ul style="list-style-type: none"> • Check that the power cable is plugged in and that the power button on the projector cabinet or the remote control is on. See pages E-17 and 18. • Ensure that the lamp cover or lamp housing is installed correctly. See page E-55. • Check to see if the projector has overheated or the lamp has reached the end of its usable life. If there is insufficient ventilation around the projector or if the room where you're presenting is particularly warm, move the projector to a cooler location. • The lamp may fail to light. Wait a full minute and then turn on the power again. • The lamp has reached the end of its usable life. Replace the lamp.
No picture	<ul style="list-style-type: none"> • Use the menu to select your source (RGB 1/2, Video, S-Video, DVI, Viewer or LAN). See page E-19. • Ensure your cables are connected properly. • Use menus to adjust the brightness and contrast. See page E-40. • Remove the lens cap. • Reset the settings or adjustments to factory preset levels using the Factory Default in the Adjustment Menu. See page E-54. • Enter your registered keyword if the Security function is enabled. See page E-53. • When using with a notebook PC, be sure to connect between the projector and the notebook PC before turning on the power to the notebook PC. In most cases signal cannot be output from RGB output unless the notebook PC is turned on after connecting with the projector. <ul style="list-style-type: none"> * If the screen goes blank while using your remote control, it may be the result of the computer's screen-saver or power management software. * If you accidentally hit the POWER button on the remote control, wait 60 seconds and then press the POWER button again to resume. • See also the next page.
Image isn't square to the screen	<ul style="list-style-type: none"> • Reposition the projector to improve its angle to the screen. See page E-19. • Use the 3DReform function to correct the trapezoid distortion. See page E-20.
Picture is blurred	<ul style="list-style-type: none"> • Adjust the focus. See page E-20. • Reposition the projector to improve its angle to the screen. See page E-19. • Ensure that the distance between the projector and screen is within the adjustment range of the lens. See page E-12 and -13. • Condensation may form on the lens if the projector is cold, brought into a warm place and is then turned on. Should this happen, let the projector stand until there is no condensation on the lens.
Image is scrolling vertically, horizontally or both	<ul style="list-style-type: none"> • Use menus or Source button on the remote control or the cabinet to select the source you want to input. • Adjust the computer image manually with the Position/Clock in the Image. See page E-41.
Remote control does not work	<ul style="list-style-type: none"> • Install new batteries. See page E-11. • Make sure there are no obstacles between you and the projector. • Stand within 22 feet (7 m) of the projector. See page E-11. • Make sure that you are in the Projector mode and the PJ button lights in red. If not, press the PJ button. See page E-24.
Indicator is lit or blinking	<ul style="list-style-type: none"> • See the Status Indicator on pages E-57.
Cross color in RGB mode	<ul style="list-style-type: none"> • If Auto Adjust is off, turn it on or adjust the image manually with the Position/Clock in the Image Options. See pages E-41 and -47.
USB mouse does not work	<ul style="list-style-type: none"> • Make sure that your USB mouse is properly connected to the projector. The projector may not support some brands of a USB mouse.

For more information contact your dealer.

If there is no picture, or the picture is not displayed correctly.

- Power on process for the projector and the PC.

Be sure to connect the RGB cable between the projector and the computer before turning on the computer. There are some notebook PCs, which do not output signal unless there is a projector or monitor connected first.

NOTE: You can check the horizontal frequency of the current signal in the projector's menu under Information. If it reads "0kHz", this means there is no signal being output from the computer. See page E-54 or go to next step.

- Enabling the computer's external display.

Displaying an image on the notebook PC's screen does not necessarily mean it outputs a signal to the projector. When using a PC compatible laptop, a combination of function keys will enable/disable the external display. Usually, the combination of the 'Fn' key along with one of the 12 function keys gets the external display to come on or off. For example, NEC laptops use Fn + F3, while Dell laptops use Fn + F8 key combinations to toggle through external display selections.

- Non-standard signal output from the computer

If the output signal from a notebook PC is not an industry standard, the projected image may not be displayed correctly. Should this happen, deactivate the notebook PC's LCD screen when the projector display is in use. Each notebook PC has a different way of deactivate/reactivate the local LCD screens as described in the previous step. Refer to your computer's documentation for detailed information.

- Image displayed is incorrect when using a Macintosh

When using a Macintosh with the projector, set the DIPswitch of the Mac adapter (not supplied with the projector) according to your resolution. After setting, restart your Macintosh for the changes to take affect.

For setting display modes other than those supported by your Macintosh and the projector, changing the DIP switch on a Mac adapter may bounce an image slightly or may display nothing. Should this happen, set the DIP switch to the 13" fixed mode and then restart your Macintosh. After that, restore the DIP switches to a displayable mode and then restart the Macintosh again.

NOTE: A Video Adapter cable manufactured by Apple Computer is needed for a PowerBook which does not have a mini D-Sub 15-pin connector.

- Mirroring on a PowerBook

- * When using the projector with a Macintosh PowerBook, output may not be set to 1024 × 768 unless "mirroring" is off on your PowerBook. Refer to owner's manual supplied with your Macintosh computer for mirroring.

- Folders or icons are hidden on the Macintosh screen

Folders or icons may not be seen on the screen. Should this happen, select [View] → [Arrange] from the Apple menu and arrange icons.

SPECIFICATIONS

This section provides technical information about the 8946 Projector's performance

Model Number 8946

Optical

LCD Panel	1.0" p-Si TFT active-matrix with Micro Lens Array
Resolution	1024 × 768 pixels up to UXGA with Advanced AccuBlend
Lens	Motorized zoom and focus: F1.74 – 2.18 f=30.8mm – 41.6mm
Lamp	300 W DC standard / 160 W DC (Optional Extended life lamp)
Color Image Sensor	23,040 pixels (160 dots × 144 lines)
Image Size	25 inches – 500 inches (0.6 m – 12.7 m) diagonal
Projection Distance	2.96 ft – 51.23 ft / 1.0 m (Tele) – 15.6 m (Wide)
Projection Angle	Tele : 10.3° – 10.7° Wide : 13.7° – 14.4°

Electrical

Inputs	2 RGB (D-Sub 15 Pin/BNC × 5), 1 DVI, 1 S-Video, 1 Video, 2 PC Card, 3 Stereo Mini Audio, 2 (L/R) RCA Audio, 1 PC Control, 1 (L/R) RCA Audio
Outputs	1 RGB, 1 Stereo Mini Audio
USB Port	1 A Type, 1 B Type
Video Compatibility	NTSC, NTSC4.43, PAL, PAL-60, PAL-N, PAL-M, SECAM, HDTV:1080p, 1080i, 720p, 576p, 576i, 480p, 480i (w/optional cable)
Scan Rate	Horizontal: 15 kHz to 100 kHz (RGB: 24 kHz or over) / Vertical: 48 Hz to 120 Hz
Video Bandwidth	RGB: 80 MHz (-3dB)
Color Reproduction	16.7 million colors simultaneously, Full color
Horizontal Resolution	NTSC / NTSC4.43/PAL/PAL-M/PAL-N/PAL60: 600 TV lines SECAM: 350 TV lines RGB: 1024 dots (H) × 768 dots (V),
External Control	RS232, IR, USB, LAN (optional)
Sync Compatibility	Separate Sync / Composite Sync / Sync on G
Built-in Speakers	5W × 2 (stereo)
Power Requirement	100 - 240V AC, 50 / 60 Hz
Input Current	4.3A
Power Consumption	1.0W in Standby mode/14W in Idle mode/415W in Lamp Normal mode/345W in Lamp Eco mode (250W in use of the optional Extended Life lamp)

Mechanical

Installation	Orientation: Desktop/Front, Desktop/Rear, Ceiling/Front, Ceiling/Rear
Dimensions	13.2" (W) × 4.5" (H) × 12.7" (D) 334mm (W) × 115mm (H) × 323mm (D) (not including protrusions)
Net Weight	13.0 lbs / 5.9 kg
Environmental Considerations	Operational Temperatures : 32° to 95°F (0° to 35°C), 20% to 80% humidity (non-condensing) Storage Temperatures : 14° to 122°F (-10° to 50°C), 20% to 80% humidity (non-condensing)
Regulations	UL/C-UL Approved (UL 60950, CSA 60950) Meets DOC Canada Class B requirements Meets FCC Class B requirements Meets AS/NZS CISPR22 Class B Meets EMC Directive (EN55022, EN55024, EN61000-3-2, EN61000-3-3) Meets Low Voltage Directive (EN60950, TUV GS Approved)

CE

For additional information visit:

US : <http://www.dukcorp.com/av>
Email : avsales@dukcorp.com
Phone : 800-676-2485

LCD panels are inherently susceptible to pixel defects.
For additional information regarding pixel data, please contact Dukane.

The specifications are subject to change without notice.

This section provides technical information about the 8805 Projector's performance

Model Number 8805

Optical

LCD Panel	1.0" p-Si TFT active-matrix with Micro Lens Array
Resolution	1024 × 768 pixels up to UXGA with Advanced AccuBlend
Lens	Motorized zoom and focus: F1.74 – 2.18 f=30.8mm – 41.6mm
Lamp	275 W DC standard / 160 W DC (Optional Extended life lamp)
Color Image Sensor	23,040 pixels (160 dots × 144 lines)
Image Size	25 inches – 500 inches (0.6 m – 12.7 m) diagonal
Projection Distance	2.96 ft – 51.23 ft / 1.0 m (Tele) – 15.6 m (Wide)
Projection Angle	Tele : 10.3° – 10.7° Wide : 13.7° – 14.4°

Electrical

Inputs	2 RGB (D-Sub 15 Pin/BNC × 5), 1 DVI, 1 S-Video, 1 Video, 2 PC Card, 3 Stereo Mini Audio, 2 (L/R) RCA Audio, 1 PC Control, 1 (L/R) RCA Audio
Outputs	1 RGB, 1 Stereo Mini Audio
USB Port	1 A Type, 1 B Type
Video Compatibility	NTSC, NTSC4.43, PAL, PAL-60, PAL-N, PAL-M, SECAM, HDTV:1080p, 1080i, 720p, 576p, 576i, 480p, 480i (w/optional cable)
Scan Rate	Horizontal: 15 kHz to 100 kHz (RGB: 24 kHz or over) / Vertical: 48 Hz to 120 Hz
Video Bandwidth	RGB: 80 MHz (-3dB)
Color Reproduction	16.7 million colors simultaneously, Full color
Horizontal Resolution	NTSC / NTSC4.43/PAL/PAL-M/PAL-N/PAL60: 550 TV lines SECAM: 350 TV lines YCbCr: 800 TV lines RGB: 1024 dots (H) × 768 dots (V),
External Control	RS232, IR, USB, LAN (optional)
Sync Compatibility	Separate Sync / Composite Sync / Sync on G
Built-in Speakers	5W × 2 (stereo)
Power Requirement	100 - 120V AC / 200 - 240V AC, 50 / 60 Hz
Input Current	4.0A (100 - 120V AC) / 2.0A (200 - 240V AC)
Power Consumption	1.0W in Standby mode/390W in Lamp Normal mode/320W in Lamp Eco mode (250W in use of the optional Extended Life lamp)

Mechanical

Installation	Orientation: Desktop/Front, Desktop/Rear, Ceiling/Front, Ceiling/Rear
Dimensions	13.2" (W) × 4.5" (H) × 12.7" (D) 334mm (W) × 115mm (H) × 323mm (D) (not including protrusions)
Net Weight	13.0 lbs / 5.9 kg
Environmental Considerations	Operational Temperatures : 32° to 95°F (0° to 35°C), 20% to 80% humidity (non-condensing) Storage Temperatures : 14° to 122°F (-10° to 50°C), 20% to 80% humidity (non-condensing)
Regulations	UL Approved (UL 1950, CSA 950) Meets DOC Canada Class B requirements Meets FCC Class B requirements Meets AS/NZS3548 Class B Meets EMC Directive (EN55022, EN55024, EN61000-3-2, EN61000-3-3) Meets Low Voltage Directive (EN60950, TUV GS Approved)

CE

For additional information visit:
US : <http://www.dukcorp.com/av>
Email: avsales@dukcorp.com
Phone: 800-676-2485

LCD panels are inherently susceptible to pixel defects.
For additional information regarding pixel data, please contact Dukane.

The specifications are subject to change without notice.

APPENDIX

Cabinet Dimensions

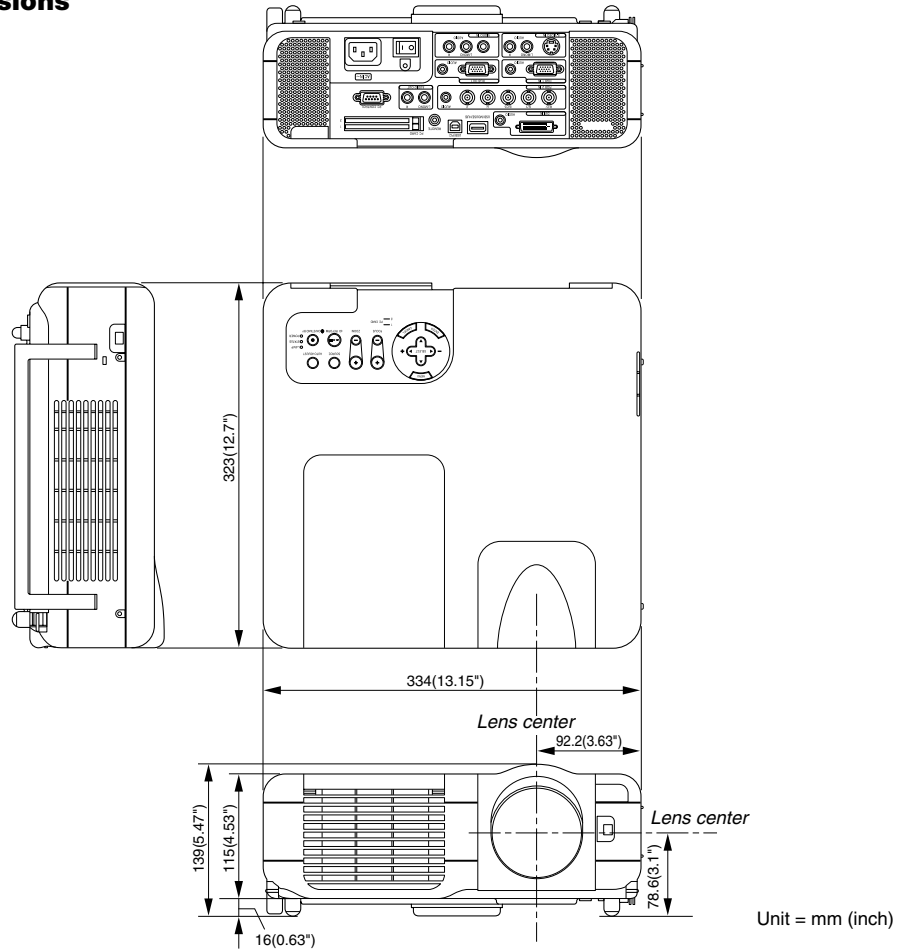

Pin Assignments of D-Sub RGB Input Connector

Mini D-Sub 15 Pin Connector

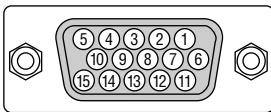

Signal Level
 Video signal : 0.7Vp-p (Analog)
 Sync signal : TTL level
 * RGB 1 Input only

Pin No.	RGB Signal (Analog)	YCbCr Signal
1	Red	Cr
2	Green or Sync on Green	Y
3	Blue	Cb
4	Ground	
5	Ground	
6	Red Ground	Cr Ground
7	Green Ground	Y Ground
8	Blue Ground	Cb Ground
9	No Connection	
10	Sync Signal Ground	
11	SCART Sync	
12	Bi-directional DATA (SDA)*	
13	Horizontal Sync or Composite Sync	
14	Vertical Sync	
15	Data Clock*	

Compatible Input Signal List

Signal	Resolution (Dots)	Frequency H. (kHz)	Refresh Rate (Hz)
NTSC	–	15.734	60
PAL	–	15.625	50
SECAM	–	15.625	50
VESA	640 × 480	31.47	59.94
IBM	640 × 480	31.47	60
MAC	640 × 480	31.47	60
MAC	640 × 480	34.97	66.67
MAC	640 × 480	35	66.67
VESA	640 × 480	37.86	72.81
VESA	640 × 480	37.5	75
IBM	640 × 480	39.375	75
VESA	640 × 480	43.269	85.01
IBM	720 × 350	31.469	70.09
VESA	720 × 400	37.927	85.04
IBM	720 × 350	39.44	87.85
IBM	720 × 400	39.44	87.85
VESA	800 × 600	35.16	56.25
VESA	800 × 600	37.879	60.32
VESA	800 × 600	48.077	72.19
VESA	800 × 600	46.88	75
VESA	800 × 600	53.674	85.06
MAC	832 × 624	49.725	74.55
VESA	1024 × 768	35.5	43 Interlaced
VESA	1024 × 768	48.363	60
VESA	1024 × 768	56.476	70.07
MAC	1024 × 768	60.241	74.93
VESA	1024 × 768	60.023	75.03
VESA	1024 × 768	68.677	85
# VESA	1152 × 864	67.5	75
# MAC	1152 × 870	68.681	75.06
# SUN	1152 × 900	61.796	65.95
# SGI	1152 × 900	71.736	76.05
# VESA	1280 × 960	60	60
# VESA	1280 × 1024	63.981	60.02
# MAC	1280 × 1024	69.89	65.2
# HP	1280 × 1024	78.125	72.01
# SUN	1280 × 1024	81.13	76.11
# VESA	1280 × 1024	79.976	75.03
# VESA	1280 × 1024	91.146	85.02
# SXGA+	1400 × 1050	–	–
# HDTV (1080p)	1920 × 1080	67.5	60
# SDTV(576i)(625i)	–	15.6	50
# SDTV(576p)(625p)	–	31.5	50
# HDTV (1080i)(1125i)	1920 × 1080	33.75	60 Interlace
# HDTV (1080i)(1125i)	1920 × 1080	28.13	50 Interlace
# HDTV (720p)(750p)	1280 × 720	45	60 Progressive
# SDTV (480p)(525p)	–	31.47	59.94 Progressive
# VESA	1600 × 1200	75.0	60
# VESA	1600 × 1200	81.3	65
# VESA	1600 × 1200	87.5	70
# VESA	1600 × 1200	93.75	75
DVD YCbCr	–	15.734	59.94 Interlaced
DVD YCbCr	–	15.625	50 Interlaced

#: Images in above flagged with # are compressed with Advanced AccuBlend.

NOTE: Some composite sync signals may not be displayed correctly.

Signals other than those specified in the table above may not be displayed correctly. If this should happen, change the refresh rate or resolution on your PC. Refer to Display Properties help section of your PC for procedures.

UXGA (1600×1200) is supported for separate sync signal only.

PC Control Codes and Cable Connection

PC Control Codes

Function	Code Data
POWER ON	02H 00H 00H 00H 02H
POWER OFF	02H 01H 00H 00H 03H
INPUT SELECT RGB 1	02H 03H 00H 00H 02H 01H 01H 09H
INPUT SELECT RGB 2	02H 03H 00H 00H 02H 01H 02H 0AH
INPUT SELECT VIDEO	02H 03H 00H 00H 02H 01H 06H 0EH
INPUT SELECT S-VIDEO	02H 03H 00H 00H 02H 01H 08H 13H
INPUT SELECT DVI (DIGITAL)	02H 03H 00H 00H 02H 01H 1AH 22H
INPUT SELECT VIEWER	02H 03H 00H 00H 02H 01H 1FH 27H
PICTURE MUTE ON	02H 10H 00H 00H 12H
PICTURE MUTE OFF	02H 11H 00H 00H 13H
SOUND MUTE ON	02H 12H 00H 00H 14H
SOUND MUTE OFF	02H 13H 00H 00H 15H
ON SCREEN MUTE ON	02H 14H 00H 00H 16H
ON SCREEN MUTE OFF	02H 15H 00H 00H 17H

NOTE: Contact your local dealer for a full list of PC Control Codes if needed.

Cable Connection

Communication Protocol

Baud rate 38400 bps
 Data length 8 bits
 Parity No parity
 Stop bit One bit
 X on/off None
 Communications procedure . Full duplex

NOTE: Depending on the equipment, a lower baud rate may be recommended for long cable runs.

PC Control Connector (D-SUB 9P)

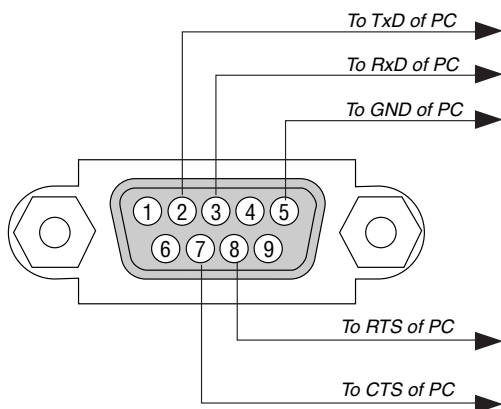

NOTE: Pins 1, 4, 6 and 9 are no used.

NOTE: Jumper "Request to Send" and "Clear to Send" together on both ends of the cable to simplify cable connection.

Using Software Keyboard



1 to 0 and Characters

- Use to type in IP address or projector name
- SP Inserts a space
- BS Deletes one character backward
- ◀ Returns to the previous
- ▶ Advances to the next
- OK Executes the selection
- Cancel Cancels the selection
- Drag bar Use to move the software keyboard on the screen.
- MODE Selects one of three modes for alphabet and special characters.

Operation Using an HTTP Browser

Overview

The use of HTTP server functions will allow control of the projector from a web browser without the installation of special software. Please be sure to use "Microsoft Internet Explorer 4.x" or a higher version for the web browser. (This device uses "JavaScript" and "Cookies" and the browser should be set to accept these functions. The setting method will vary depending on the version of browser. Please refer to the help files and the other information provided in your software.)

NOTE:

- * The use of HTTP server functions is not available during Standby mode.
- * The display's or button's response can be slowed down or operation may not be accepted depending the settings of your network. Should this happen, consult your network administrator.
- * The projector may not respond if its buttons are repeatedly pressed in rapid intervals. Should this happen, wait a moment and repeat. If you still can't get any response, pull out and then re-insert the LAN card.
- * Do not use the HTTP Server functions and the Dynamic Image Utility included on the supplied CD-ROM. Using both at the same time may result in a connection failure or slow response.

Access is gained to the HTTP server functions by specifying `http://<the projector's IP address>/index.html` in the entry column of the URL.

Preparation Before Use

Make network connections and set up the projector and confirm that it is complete before engaging in browser operations. (See "Setting LAN Mode" on page E-50.)

Operation with a browser that uses a proxy server may not be possible depending on the type of proxy server and the setting method. Although the type of proxy server will be a factor, it is possible that items that have actually been set will not be displayed depending on the effectiveness of the cache, and the contents set from the browser may not be reflected in operation. It is recommended that a proxy server not be used unless it is unavoidable.

Handling of the Address for Operation via a Browser

Regarding the actual address that is entered for the address or entered to the URL column when operation of the projector is via a browser, the host name can be used as it is when the host name corresponding to the IP address of the projector has been registered to the domain name server by a network administrator, or the host name corresponding to the IP address of the projector has been set in the "HOSTS" file of the computer being used.

Example 1: When the host name of the projector has been set to "pj.nec.co.jp", `http://pj.nec.co.jp/index.html` is specified for the address or the entry column of the URL.

Example 2: When the IP address of the projector is "192.168.73.1", access is gained to the HTTP server functions by specifying `http://192.168.73.1/index.html` for the address or the entry column of the URL.

Structure of the HTTP Server

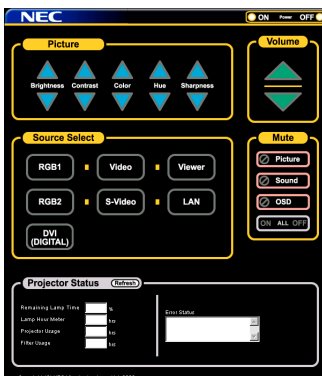

Power: This controls the power of the projector.

- On Power is switched on.
- Off Power is switched off.

Volume: This controls the volume of the projector.

- ▲ Increments the volume adjustment value.
- ▼ Decrements the volume adjustment value.

Mute: This controls the mute function of the projector.

- All On Mutes each of the video, audio, and on-screen display functions.
- All Off Cancels the muting of each of the video, audio, and on-screen display functions.
- Picture On Mutes the video.
- Picture Off Cancels the video muting.
- Sound On Mutes the audio.
- Sound Off Cancels the audio muting.
- OSD On Mutes the on-screen display.
- OSD Off Cancels the muting of the on-screen display.

Picture: Controls the video adjustment of the projector.

- Brightness ▲ .. Increments the brightness adjustment value.
- Brightness ▼ .. Decrements the brightness adjustment value.
- Contrast ▲ Increments the contrast adjustment value.
- Contrast ▼ Decrements the contrast adjustment value.
- Color ▲ Increments the color adjustment value.
- Color ▼ Decrements the color adjustment value.
- Hue ▲ Increments the hue adjustment value.
- Hue ▼ Decrements the hue adjustment value.
- Sharpness ▲ . Increments the sharpness adjustment value.
- Sharpness ▼ . Decrements the sharpness adjustment value.

* The functions that can be controlled will vary depending on the signal being input to the projector.

Source Select: This switches the input connector of the projector.

- RGB1 Switches to the RGB 1 connector.
- RGB2 Switches to the RGB 2 connector.
- Video Switches to the Video connector.
- S-Video Switches to the S-Video connector.
- DVI(DIGITAL) . Switches to the DVI connector
- Viewer Switches to the Viewer.
- LAN Switches to a LAN signal.

Projector Status: This displays the condition of the projector.

- Remaining Lamp Time .. Displays the remaining life of the lamp as a percentage.
- Lamp Hour Meter Displays how many hours the lamp has been used.
- Projector Usage Displays how many hours the projector has been used.
- Filter Usage Displays how many hours the filter has been used.
- Error Status Displays the status of errors occurring within the projector.
- Refresh Updates the display of the following conditions.

Audio Visual Products

Dukane Corporation
Audio Visual Products Division
2900 Dukane Drive
St. Charles, IL 60174-3395
E-mail: avsales@dukcorp.com

Phone: (630) 762-4040
Orders: (800) 676-2485
Fax: (630) 584-5156
Parts & Service: (800) 676-2487
Fax: (630) 584-0984

DUKANE

Part # 401-8805/8946-00